

COVAL

vacuum managers

CVGL

Compact and Light Vacuum Grippers



NFC)))

IO-Link

ADVANCED VACUUM SOLUTIONS

CVGL

Compact and Light Vacuum Grippers

General Information

With the CVGL series, COVAL introduces a universal solution to the vacuum gripper that is flexible, simple, and economical.

Handling parts of various sizes, shapes, and weights is no longer a complex, costly, and time-consuming task.

With a single CVGL module easily integrated into the process, the user can simply and safely perform random gripping of assorted parts.



Industry-specific applications

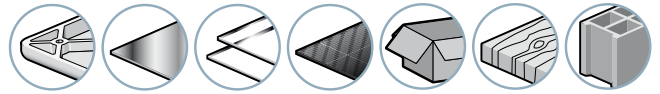

Advantages

The CVGL series is composed of standard subassemblies which allow COVAL to offer a tailor-made solution meeting the specific application requirements of integrators and end users:

- Compact
- Lightweight
- Integrated functions
- Communicating
- Modularity
- Performance
- Ease of use
- Universal mounting

A Complete System

Simply configure your CVGL vacuum gripper:

- 1 light and robust aluminum profile
- 1 universal mounting system
- 3 standard lengths (424, 624, 824mm)
- 3 suction levels
- 3 gripping interface technologies
- 3 standard hole/cup patterns
- 3 flow control technologies
- 2 control versions (vacuum and blow-off)
- 2 solutions for vacuum display
- + The Vacuum Manager experience of COVAL

= YOUR CVGL SOLUTION

FOAM Gripping Interface

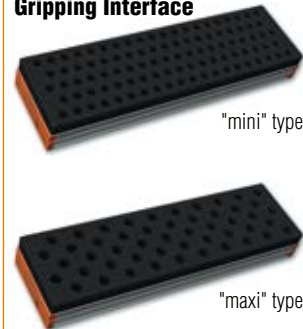

SUCTION CUPS Gripping Interface

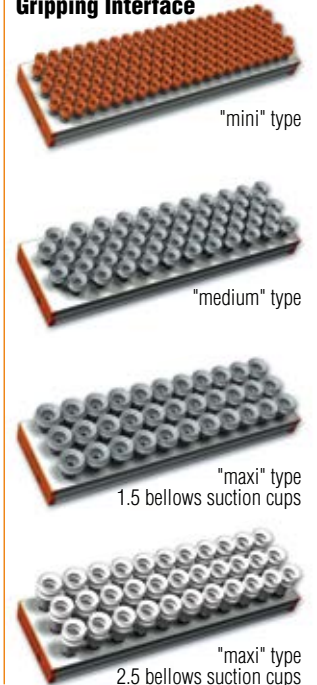

"COVAL-flex" Gripping Interface



Applications

The CVGL series vacuum grippers offer a single solution for the handling of products in multiple industrial sectors:

- Packaging
- Plastics
- Metal
- Glass
- Concrete/stone
- Composites
- Wood

The adaptability and the flexibility of COVAL CVGL Series vacuum grippers responds to numerous robotic applications.



CVGL

Compact and Light Vacuum Grippers

General Information



Modular Grippers



Ultra-light
Reduced payload weight



External or integrated vacuum generation



3 standard lengths
424, 624, and 824 mm



3 flow control technologies



Configurable gripping interface
depending on the products to be handled



Communication and Control

- Digital inputs/outputs (SIO)/IO-Link
- HMI
- NFC

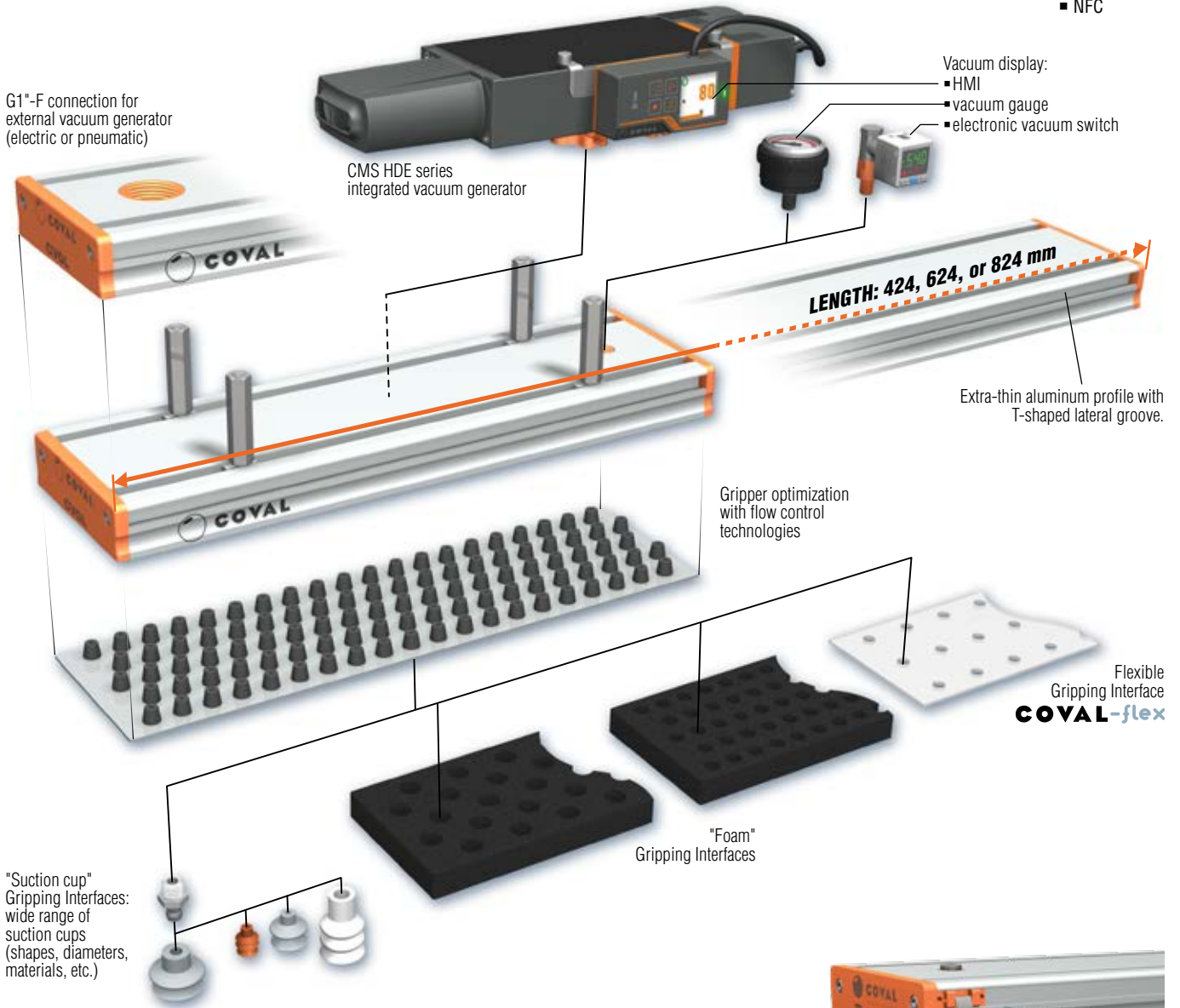

Gripper interface quick change system, ref: CVGL ___ C

To simplify maintenance and increase the flexibility of the CVGL series vacuum grippers, COVAL has developed an ultra-compact and easy-to-use solution for replacing the gripper interface. Very straightforward, the spring-loaded clips allow you to replace a worn or damaged gripper interface in a matter of seconds, or to install another type of interface (foam / suction cups / COVAL-flex).

Number of clips according to the length of the gripper:

- CVGL424: 6 clips.
- CVGL624: 8 clips.
- CVGL824: 10 clips.



CVGL

Compact and Light Vacuum Grippers

General Information



Multi-zone

CVGL vacuum grippers can create independent gripping zones, guaranteeing optimization of vacuum management (increased vacuum level, reduced leaks and energy consumption).

- Staggered grip/release points.
- Management of formats to be handled.
- Pallet Layer Optimization.
- Simple or multiple grip/release points.

As each multi-zone application is different, COVAL will work with you to determine the best configuration for your process.

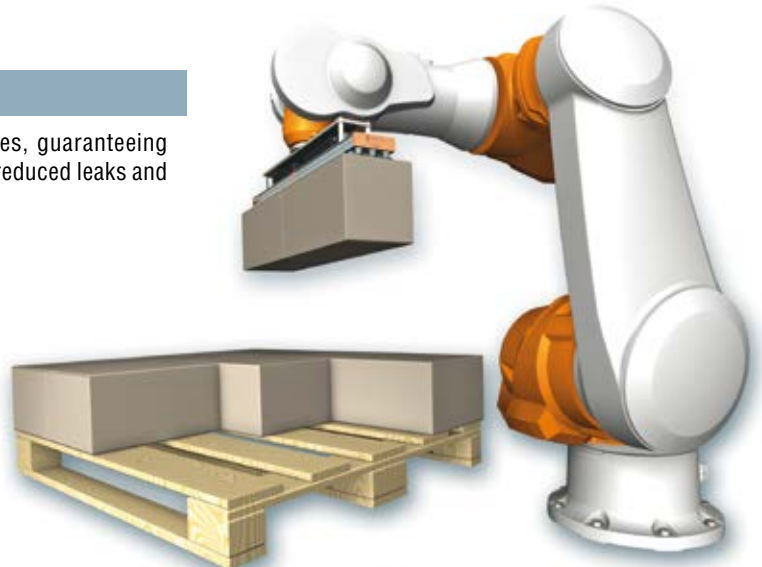

Examples of configuration:

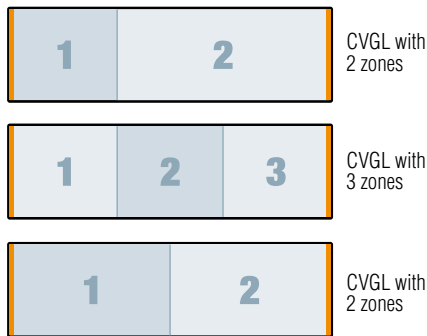

Ultra-light and compact design

The main design objective of the CVGL vacuum gripper is to minimize space and weight, while maintaining a highly modular configuration, to meet the needs of robotic applications.

Thanks to COVAL's aluminum profile, the CVGL vacuum grippers fully meet this objective. The ultra-thin profile allows for easy integration on robots.

The CVGL profile integrates the vacuum connections on the upper part, which provides greater compactness, as well as a T-slot on the side for mounting additional accessories such as sensors.

The technologies and materials used in the design of the CVGL vacuum gripper considerably reduce the on-board weight. This makes the CVGL the benchmark in its field, allowing smaller robots to be used, increasing accelerations and thus optimizing the installation in order to achieve savings.

Mass (in kg) depending on options

GRIPPING INTERFACE	Length (mm)	Vacuum gripper without vacuum generator (G0)	Vacuum gripper with 1 CSMHDE_50_ vacuum generator (D1)		Vacuum gripper with 1 CSMHDE_100_ vacuum generator (D2)		Vacuum gripper with 2 CSMHDE_100_ vacuum generators (D3)
			without control	with control	without control	with control	without control
Foam Interface Mini F2S / Maxi F2B type with flow control nozzles (H version)	424	1.8	2.4	2.7	2.4	2.7	–
	624	2.6	–	–	3.2	3.5	–
	824	3.4	–	–	4.0	4.3	4.6
Foam Interface Mini F2S / Maxi F2B type with airtight or check valves (E and V versions)	424	2.0	2.6	2.9	2.6	2.9	–
	624	2.8	–	–	3.4	3.7	–
	824	3.7	–	–	4.3	4.6	4.9
Suction cup Interface Mini, Medium, or Maxi type with flow control nozzles (H version)	424	2.2	2.8	3.1	2.8	3.1	–
	624	3.2	–	–	3.8	4.1	–
	824	4.1	–	–	4.7	5.1	5.3

Average values shown



Choice of Gripping Interface

With CVGL, COVAL gives you a choice of 3 complementary gripping interface technologies: vacuum grippers with foam, suction cup grippers, and grippers with a COVAL-flex interface.

In order to optimize the performance of the CVGL series for different applications, the vacuum grippers are available in different gripping patterns, hole diameters, and cup sizes → A broad range which meets all application requirements.

"FOAM" Interface

- Handling of rigid products.
- Gripping textured or uneven surfaces.
- Flow control nozzles, airtight valves, or check valves.
- 2 standard hole diameters (Ø 12, 16mm).
- 2 standard hole patterns.
- 3 standard lengths (424, 624, and 824mm) or custom length.

"SUCTION CUP" Interface

- Handling of flexible products.
- Wide range of cup options.
- Flow control nozzles in multiple diameters.
- 4 types of standard suction cups (Ø 14, Ø 25, Ø 30 and Ø 33 mm).
- 3 standard cup patterns.
- 3 standard lengths (424, 624, and 824mm) or custom length.

"COVAL-flex" Interface

- Handling of aluminum cans, canned food, glass containers, etc.
- Flexible interface, extremely tear-resistant.
- Hole pattern dependent upon application requirements, completely customizable.



COVAL-flex

Standard Hole/Cup Patterns

In order to optimize the performance of the CVGL series for different applications, the vacuum grippers are available in different gripping patterns, hole diameters, and cup sizes.

"MINI" type

- Reduced hole spacing, allowing small, flexible pieces to be gripped.
- The multitude of gripping points guarantees a strong grip, even with random positioning of products.
- Dimensions, refer to page 18.

"MEDIUM" type

- An intermediate distribution of gripping points between the "mini" and "maxi" type.
- Ideal for handling dense loads with reduced gripping surface.
- Dimensions, refer to page 18.

"MAXI" type

- Large gripping point surfaces, allowing heavy loads to be gripped.
- Ideal for gripping parts with rigid gripping surfaces.
- Dimensions, refer to page 18.

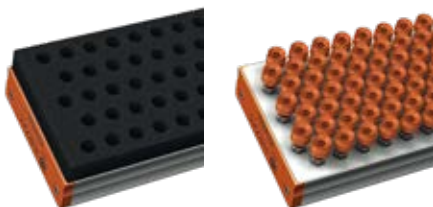

Vacuum Gripping Force

** Indicative force for a vacuum gripper 100% covered by the load, without safety factor, on a rigid and airtight surface.*

Part number	Total length of the vacuum gripper (mm)	Force at 80% vacuum (N)*	Force at 45% vacuum (N)*
CVGL 424_ _ _ _	424	1035	600
CVGL 624_ _ _ _	624	1550	900
CVGL 824_ _ _ _	824	2070	1200



Flow Control Technologies

COVAL offers 3 flow control technologies to optimize your vacuum gripper and perfectly respond to the constraints of your application.

The COVAL vacuum management team will assist you in the selection and configuration of your CVGL vacuum gripper.

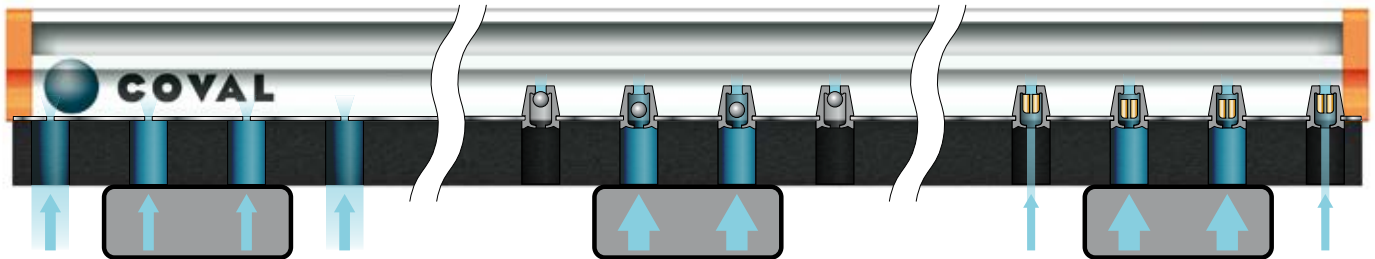

Flow control nozzles

- Limits the leakage rate of uncovered zones.
- Economic solution.
- Customizable calibration.
- Horizontal and vertical handling.

Airtight valves (COVAL patent)

- Isolates uncovered zones.
- Provides energy savings.
- Meets specific needs.
- Instant gripping.
- Quick release to blow-off.
- Horizontal handling.

Check valves (COVAL patent)

- Limits the leakage rate of uncovered zones.
- Instant gripping.
- High versatility of applications.
- Quick release to blow-off.
- Horizontal handling.

Vacuum Generation

Integrated vacuum generator, CMS HDE Series

Integration of a multi-stage vacuum generator on the CVGL gripper provides a comprehensive and compact gripping solution, as well as easy integration in your process.

Options: integration of a vacuum and/or blow-off solenoid control valve with M12 connector and a vacuum level display (electronic vacuum switch display or vacuum gauge), or HMI with LCD display.

Advantages:

- A comprehensive solution.
- 3 standard sizes.
- Option: vacuum and blow-off control valve.
- Option: visual display of vacuum level.
- Option: IO-Link communication interface.



External vacuum generator

The CVGL vacuum grippers may also be used with an independent vacuum generator. Depending on the application, an external generator may be necessary (a blower, an electric vacuum pump or a pneumatic generator, CMS HD Series). The CVGL series vacuum gripper G0 version is equipped with a G1"-F flange allowing the vacuum source to be easily connected.

Option: integration of a vacuum level display (electronic vacuum switch display or vacuum gauge).

Advantages:

- Reduced weight.
- Adaptation to user environment.
- Option: visual display of vacuum level.

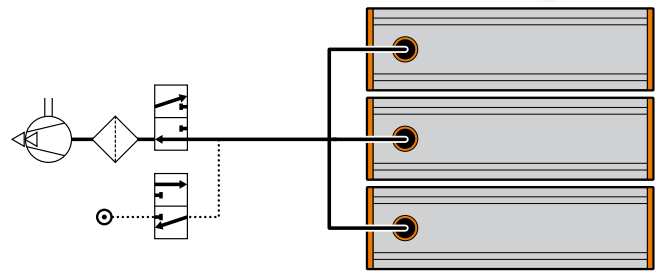
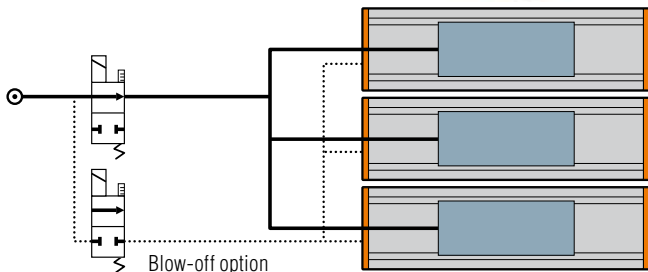

Technical data of the CMS HDE series integrated vacuum generators

Integrated vacuum generator	Model	Consumption (NI/min)	Flow rate (NI/min)	Max. vacuum (%)	Sound level (dBA)
CVGL___D1	CMSHDE_50	220	700	80	59
CVGL___D2	CMSHDE_100	420	1100	80	62
CVGL___D3	2xCMSHDE_100	840	2200	80	65

Generator configurations by vacuum gripper length

Vacuum generator	CVGL 424 _	CVGL 624 _	CVGL 824 _
G0	■	■	■
CMSHDE_50 (D1 Version)	■	-	-
CMSHDE_100 (D2 Version)	■	■	■
2xCMSHDE_100 (D3 Version)	-	-	■

CVGL

Compact and Light Vacuum Grippers Integrated Multi-stage Vacuum Pumps



The CVGL vacuum grippers have a wide range of configurations with the CMS HDE Series multi-stage vacuum pumps, allowing for a specialized solution for each application.

CVGL_D_NOK

CMSHDE_NVOG4K multi-stage vacuum pump

- Without control.



CVGL_D_S1 / V1K

CMSHDE_VOC15PG4K multi-stage vacuum pump

- With vacuum and blow-off control.
- Without vacuum switch.
- One M12 5-pin connector.
- Visual indicators of vacuum and blow-off controls.
- Digital inputs/outputs mode.



CVGL_D_S2 / V2K

CMSHDE_VXC15PG4KD multi-stage vacuum pump

- With vacuum and blow-off control.
- With vacuum switch, and pressure sensor.
- One M12 5-pin connector.
- One M8 4-pin connector for HMI (VI option).
- Digital inputs/outputs (SIO) / IO-Link Mode.



VI Version: Clear and efficient HMI: includes all required inputs for full operation of CMS HDE multi-stage vacuum pumps.

Gripping status indicator light (2 colors).

1.54" high-visibility color LCD display with clear multilingual messages and straightforward settings menu.

Settings keypad.



NFC)))

Straightforward setup and diagnostics made possible by NFC technology and COVAL Vacuum Manager mobile application.



Onboard installation and diagnostic tools:

- Clog detection.
- Supply pressure and voltage monitoring.

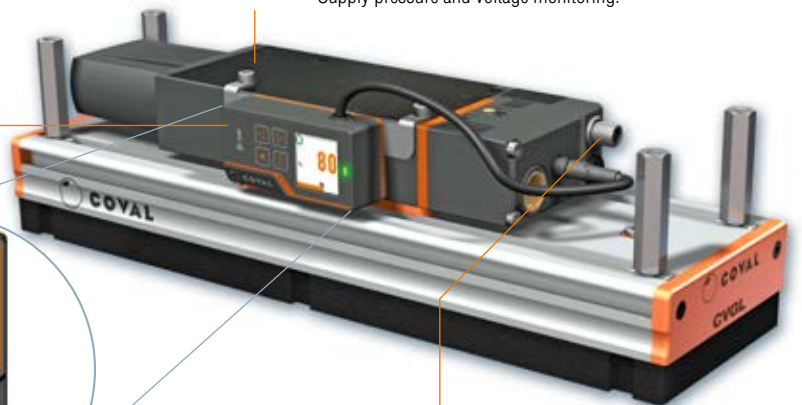

Digital inputs/outputs (SIO) / IO-Link

- M12 5-pin connector.

Modularity/Maintenance

The CMS HDE multi-stage vacuum pumps have been designed to withstand the demands from all your applications and to guarantee a high level of performance. However, handling certain parts may require replacement or cleaning.

The modular design of the CMS HDE multi-stage pumps ensures easy maintenance as the functions are all easily accessible.

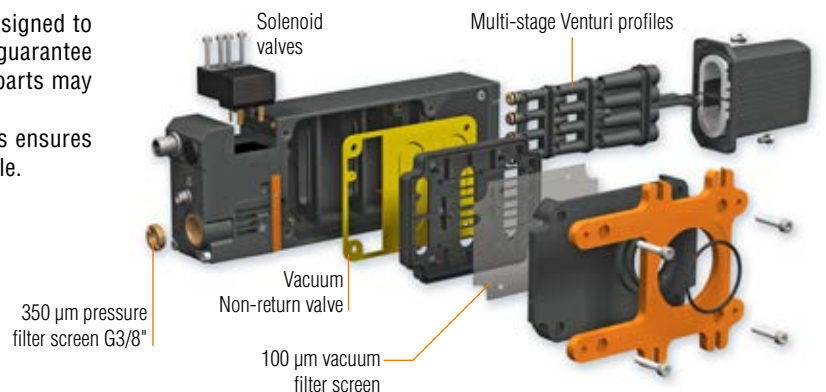



Easier Integration, Use, and Diagnostics

The **CMSHD__VX** Heavy Duty multi-stage vacuum pump series includes various features that enable setup, use, and diagnostics in all situations and at all levels (operators, process, networked

factory), with the aim in mind of keeping the use and management of the pumps as straightforward as possible and thus allowing for their easy integration in your smart factory.

Settings, Diagnostics, and Process Data



CONFIGURABLE SETTINGS

- Choice of language: EN, FR, DE, IT or ES.
- "Object gripped" thresholds.
- Automatic blow-off.
- Vacuum measurement unit: kPa, %, mbar, inHg.
- Pressure measurement unit: MPa, bar, psi.
- Software updates, and more.



DIAGNOSTICS

- Cycle counters (vacuum and blow-off control, objects gripped, objects lost, etc.).
- Vacuum network sizing support to prevent pressure loss.
- Clogging detection function.
- Supply pressure and voltage monitoring.
- Software version.
- Product part number and serial number.



PROCESS INPUT DATA

- Vacuum and blow-off control.



PROCESS OUTPUT DATA

- Instantaneous vacuum level.
- Object gripped and object lost information.
- Alarms (high/low pressure, high/low voltage).
- Instantaneous pressure.



IO-Link

The IO-Link system provides efficient real-time communication between **CMSHDE_VXC15X** multi-stage vacuum pumps and any higher-level protocol (EtherNet/IP, PROFINET, EtherCAT, etc.) required to monitor the production line. It can be used to control pumps, configure settings, and get feedback to ensure maximum productivity.

Advantages:

- Straightforward wiring, installation, and setup
- Availability of diagnostic status data
- Simpler preventive maintenance and vacuum pump replacement without manual setup, and more
- Onboard installation and diagnostic tools

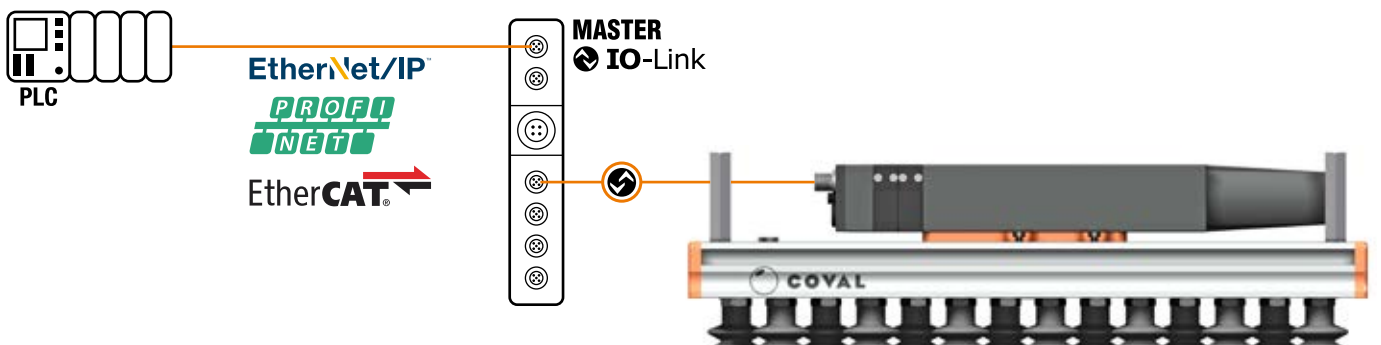

Compact and Light Vacuum Grippers Straightforward Communication



Mounted or Remote HMI

To facilitate the use and configuration of the vacuum generator, the CVGL range has an HMI that can be mounted on the generator or used remotely.

Advantages:

- Position the HMI on the vacuum generator or in an easily accessible and visible area.
- Use one HMI for multiple vacuum generators.
- Copy settings from one vacuum generator to the next.
- The vacuum generator will continue to operate with the HMI removed.

CVGL vacuum generators compatible with HMI:

→ CVGL__S2 / V2__ versions with M8 connector.

CVGL__VI version:

- HMI (ref: **HMIHD1M84P**) + mounting plate (**HMIHD1FIXC**) mounted on the vacuum generator.

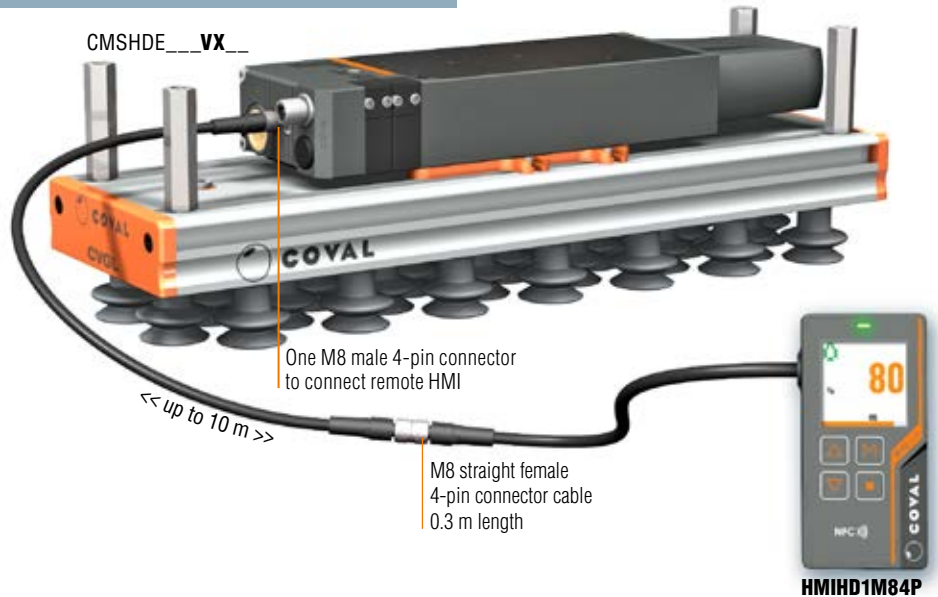
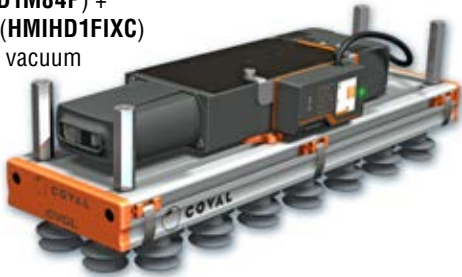

HMIHD1M84P

- Accessory: Remote HMI
- Ref: **HMIHD1M84P** (see accessories for HMI page 10).

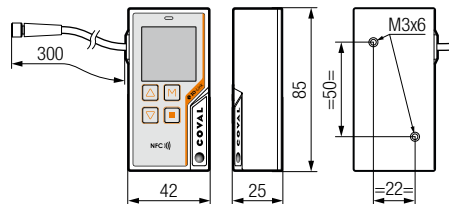

Note: all dimensions are in mm.

Remote HMI Dialog Front Panel



The HMI allows for a simple and efficient reading of the pump's operation. The high-visibility display includes all required inputs for full operation:

- Main information is easy to read
- Multilingual: EN - FR - DE - IT - ES
- Simple and clear event messages
- Intuitive settings and diagnostics menus
- Configurable display orientation: 0 - 90 - 180 - 270°
- Lockable to prevent undesired changes

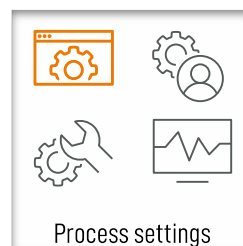

Multilingual

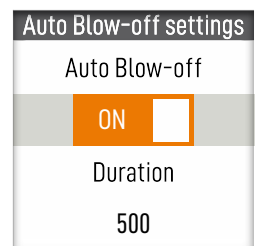

EN FR DE IT ES

Compact and Light Vacuum Grippers Straightforward Communication



NFC)))

The NFC wireless technology integrated in remote HMI and in the COVAL Vacuum Manager application makes all setup and diagnostic functions available and modifiable on your mobile devices.

Additional features:

- Read/write settings with the power on or off.
- Copy settings from one CMS HD to another.
- Backup up to 5 setting configurations.
- COVAL support: send a report including the settings and diagnostic data to COVAL for technical support.



NFC APP: COVAL Vacuum Manager
Available for Android and iOS

Accessories for HMI

Front mounting plate
+ 2 x M3x6 TORX
+ 2 x M5x50 CHC
Part No.: **HMIHD1FIXA**

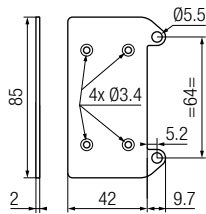

Side mounting plate
+ 2 x M3x6 TORX
+ 2 x M5x50 CHC
Part No.: **HMIHD1FIXC**

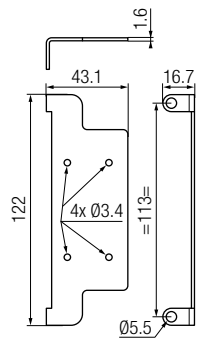

90° angled mounting plate
+ 2 x M3x6 TORX
Part No.: **HMIHD1FIXB**

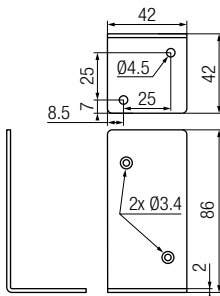

Connecting cable

M8 4-pin, female / M8 4-pin, male, compatible with cable chain

- 2 m length: Part No. **CDM8MF4PL2**
- 5 m length: Part No. **CDM8MF4PL5**
- Other lengths available upon request.



Note: all dimensions are in mm.

CVGL

Compact and Light Vacuum Grippers

Selection guide



Multi-stage Vacuum Control

When necessary, the CVGL series vacuum grippers with integrated vacuum generator (versions D1 and D2) can be equipped with a vacuum and/or blow-off control valve to optimize product release. This also enables cleaning of the vacuum network, flow control nozzles, check valves, or airtight valves.

A vacuum switch or analog gauge is available as an option for those requiring a visual display of the vacuum level in the system (see below).

Vacuum Control: 2 Solutions

Model CVGL_S: vacuum pump with **NC** vacuum control and **NC** blow-off control. In the event of power failure, vacuum is no longer generated. In the event of compressed air failure, the vacuum is no longer maintained.

- **NC** blow-off and vacuum control: solenoid valves
- Choice of blow-off settings (only on CVGL_S2 models):
 - controlled by external signal
 - automatic timer from 50 to 9999 ms (advantage: saves one controller output)

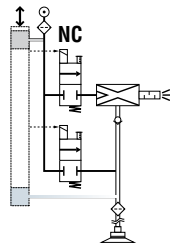

Model CVGL_V: vacuum pump with **NO** vacuum control and **NC** blow-off control. In the event of power failure, vacuum is still generated: object is held in place → fail-safe.

In the event of compressed air failure, the vacuum is no longer maintained.

- **NO** vacuum control solenoid valve
- **NC** blow-off control solenoid valve
- Blow-off controlled by external signal

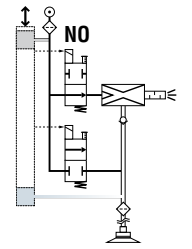

Electrical Connections

CVGL_S1 / V1:

- One M12 5-pin male connector

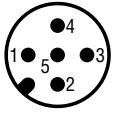

- | | |
|---|--|
| 1 | / |
| 2 | 24 V DC suction command ⁽¹⁾ |
| 3 | 0 V - GND |
| 4 | 24 V DC blow-off command |
| 5 | / |

⊗ : connections for ⊗ IO-Link

⁽¹⁾ 24 V DC suction command, depending on version:

- **S**: 24 V DC vacuum control
- **V**: 24 V DC vacuum off command



CVGL_S2 / V2:

- One M12 5-pin male connector

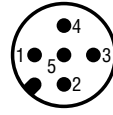

- | | |
|---|--|
| 1 | ⊗ 24 V DC |
| 2 | 24 V DC suction command ⁽¹⁾ |
| 3 | 0 V - GND |
| 4 | ⊗ 24 V DC object gripped D01 - C/Q |
| 5 | 24 V DC blow-off command |

- One M8 4-pin male connector → HMI



- | | |
|---|---------------|
| 1 | 24 V CC |
| 2 | RS485 (DATA+) |
| 3 | 0 V - GND |
| 4 | RS485 (DATA-) |



Vacuum Level Display

When required, CVGL series grippers can incorporate a vacuum level display with an electronic vacuum switch or vacuum gauge:

■ Option VA - electronic vacuum switch

with 3-color display (PSD100CPNP):

CVGL _____ X __ **VA**

- Pressure rating range: 0 ~ -101.3 kPa.
- Pressure setting range: 10 ~ -101.3 kPa.
- Max. pressure: 300 kPa.
- Fluid: Air, non-corrosive/non-flammable gas.
- Hysteresis: adjustable.
- Response time: ≤ 2.5ms, with anti-vibration function.
- 7 segment LCD display: 2 color (red/green) main display, orange sub-display (refresh rate: 5 times/1sec.)
- Choice of pressure unit display: kPa, MPa, kgf/cm², bar, psi, inHg, mmHg.
- Power supply voltage: 12 to 24 V DC ±10%.
- Current consumption: ≤ 40 mA (without load).
- Repeatability (switch output): ≤ ±0.2% F.S. ±1 digit.
- Electrical connection: M8 (4-pin).
- Protection: IP40.
- Ambient temperature range: 0 – 50° C (operation).
- Material (enclosure): PA 6.6 20%GF.

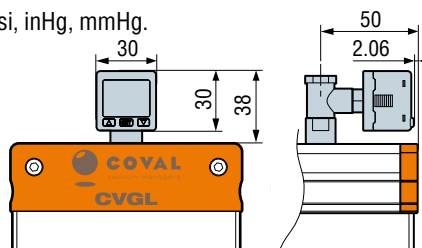

■ Option VF - vacuum gauge

(VAF11140):

CVGL _____ X __ **VF**

- Vacuum gauge with needle.
- Damping: by silicone movement (patented).
- Measuring: Bourdon tube in CuSn.
- Precision: cl. 2.5 (+/- 2.5% of max. scale value).
- Frame: black ABS

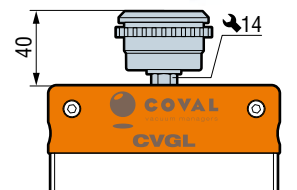

Note: all dimensions are in mm.

CVGL

Compact and Light Vacuum Grippers

Configuring a CVGL Vacuum Gripper



	CVGL	424	D	VSA33JK	X	H	X
--	-------------	------------	----------	----------------	----------	----------	----------

OVERALL LENGTH			ASSEMBLY TYPE
424 mm	424		X Screw mounting
624 mm	624		C Quick-mounting spring clips
824 mm	824		

HOLE/CUP PATTERN LAYOUT		
Staggered	Q	
Straight*	D	

** Only available for "maxi" type gripping interface with minimum suction cup Ø 26mm.*

SUCTION CUPS GRIPPING INTERFACES		FILTER	TECHNOLOGY
<p>"mini" type interface: 2.5 bellows suction cups Ø 14 mm in silicone 30 Shore with flow control nozzles.</p>	VSP14BF	X Without	H Flow control nozzles
<p>"medium" type interface: 1.5 bellows suction cups Ø 25 mm in natural rubber with flow control nozzles.</p>	VSA25JI		
<p>"maxi" type interface: 1.5 bellows suction cups Ø 33 mm in natural rubber with flow control nozzles.</p>	VSA33JK		
<p>"maxi" type interface: 2.5 bellows suction cups Ø 30 mm in white silicone 35 Shore with flow control nozzles.</p>	MVS30EK		

FOAM GRIPPING INTERFACES		FILTER	TECHNOLOGY
<p>Foam "mini" type interface, EPDM (thickness 20 mm)</p>	F2S	X Without	H Flow control nozzles
<p>Foam "maxi" type interface, EPDM (thickness 20 mm)</p>	F2B	F With filter	E Airtight valves

COVAL-flex GRIPPING INTERFACES		TECHNOLOGY
<p>"COVAL-flex" gripping interfaces are designed to respond to specific applications. Our vacuum team will recommend and define any applications of yours which can benefit from its special features.</p>		V Check valves

SPECIAL VERSIONS

There can be instances where the standard CVGL versions will not match your application requirements. COVAL can provide you personalized solutions based on your specifications, by integrating specific function and suggesting custom lengths and suction cup types.



	D1	S		1		K		VA
VERSION WITHOUT VACUUM GENERATOR			GENERATOR CONTROL		GENERATOR CONFIGURATION		EXHAUST	
Without vacuum generator	G0	N	Without	0	Without	X	Without	
VERSIONS WITH VACUUM GENERATOR*			GENERATOR CONTROL		GENERATOR CONFIGURATION		EXHAUST	
1 x CMSHDE_50 multi-stage vacuum pump Flow rate: 700 NI/min	D1	N	Without	0	Without	K	Through-type silencer	
1 x CMSHDE_100 multi-stage vacuum pump Flow rate: 1100 NI/min	D2	S*	CMSHDE_S_ Vacuum pump with NC vacuum control and NC blow-off control. Choice of blow-off settings (only on CVGL__S2_models): ▪ Controlled by external signal ▪ Automatic timer from 50 to 9999 ms (advantage: saves one controller output).	1	CMSHDE__VOC15P_ Multi-stage vacuum pump without vacuum switch and HMI ▪ One M12 5-pin male PNP ▪ Digital inputs/ outputs mode (SIO)			
2 x CMSHDE_100 multi-stage vacuum pump Flow rate: 2200 NI/min	D3	V*	CMSHDE_V_ Vacuum pump with NO vacuum control and NC blow-off control. ▪ Blow-off controlled by external signal	2	CMSHDE__VXC15X_ Multi-stage vacuum pump with integrated vacuum switch and pressure sensor, without HMI ▪ One M12 5-pin male configurable as PNP or NPN ▪ One M8 4-pin male for remote HMI ▪ Electronic vacuum switch ▪ Digital Output DO1 "object gripped" 24 V DC / NO ▪ Digital input/ outputs mode (SIO) / IO-Link ▪ Compatible with HMI (for VI option)			
* See p.6 table of possible configurations								
* Only for D1 and D2.								
VACUUM LEVEL DISPLAY								
Without								VO
	Vacuum switch with electronic display							VA
	Vacuum gauge (for versions with control, option available for 624 mm in length and longer)							VF
	HMI on CMS HDE (compatible with S2 and V2 versions only)							VI

CVGL

Compact and Light Vacuum Grippers

Examples of Composed Part Numbers



CVGL424DVSA33JKXHXD2S1KVA

CVGL vacuum gripper length 424mm, "straight" cup pattern layout, "maxi" type gripping interface, 1.5 bellows suction cups Ø33mm in natural rubber with flow control nozzles, with 1 integrated vacuum generator CMSHDE_100, vacuum generator control and NC blow-off, vacuum level display with electronic display vacuum switch.

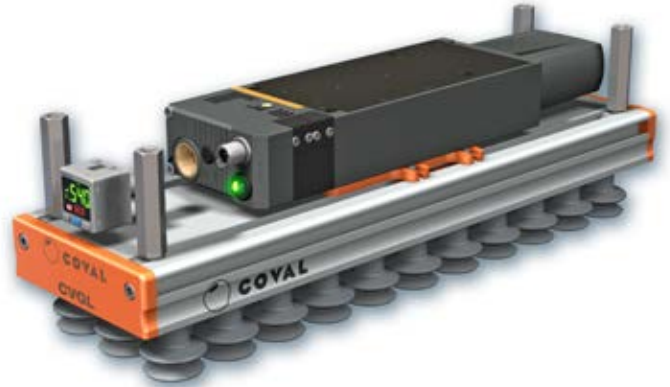

CVGL424QVSP14BFXHCD1N0KVF

CVGL vacuum gripper length 424mm, "staggered" cup pattern layout, "mini" type gripping interface, 2.5 bellows suction cups Ø33mm in silicon 30 Shore with flow control nozzles, with 1 integrated vacuum generator CMSHDE_50, without vacuum generator control and vacuum level display with mechanical gauge vacuum switch.

CVGL624QMVS30EKXHXGONOXVA

CVGL vacuum gripper length 624mm, "staggered" cup pattern layout, "maxi" type gripping interface, 2.5 bellows suction cups Ø30mm in silicon 30 Shore with flow control nozzles, without vacuum generator, and vacuum level display with electronic display vacuum switch.



CVGL624QF2BFVD2S2KVI

CVGL vacuum gripper length 624mm, "staggered" hole pattern, foam "maxi" interface with quick mounting spring clips, with filter and check valves, with CMSHDE_100_ multi-stage vacuum pump, with through-type silencer, NC vacuum control and blow-off, with HMI display.

CVGL

Compact and Light Vacuum Grippers

Examples of Composed Part Numbers



CVGL824QF2SXHCGON0XVF

CVGL vacuum gripper length 824mm, "staggered" cup pattern layout, foam "mini" type gripping interface with quick mounting spring clips, without filter, with flow control nozzles, without vacuum generator, with vacuum level display with mechanical gauge vacuum switch.

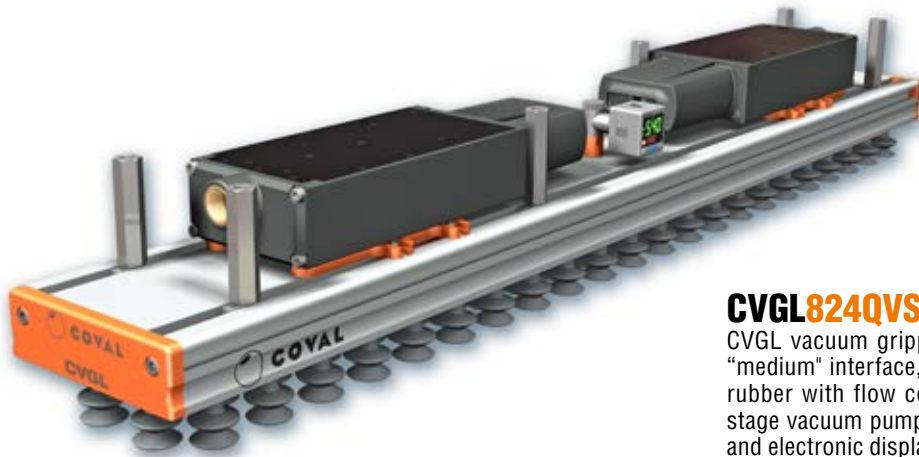

CVGL824QVSA25JIXHXD3NOKVA

CVGL vacuum gripper length 824mm, "staggered" cup pattern, "medium" interface, suction cups 1.5 bellows Ø25 mm in natural rubber with flow control nozzles, with 2 CMSHDE_100_ multi-stage vacuum pumps without control, with through-type silencer, and electronic display vacuum switch.

MVG Series modular vacuum grippers

For applications requiring customized dimensions, COVAL has developed a modular vacuum gripper, the **MVG Series**.

Thanks to their modularity, the MVG vacuum grippers offer the optimal handling solution for various sizes, shapes, and weights.

- Customized formats from 150x150mm to 1200x1000mm.
- Configurable gripping interface (foam, suction cups, or COVAL-flex).
- Multi-zone.
- Staggered grip / release points.
- Integrated or external vacuum generator.
- Adaptable to all industry sectors.

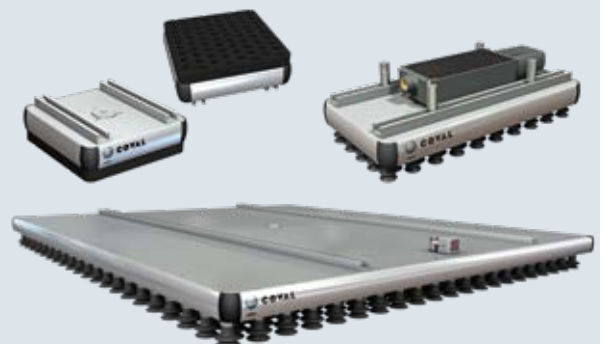



G0 versions

(with external vacuum generator).

The COVAL CVGL series vacuum grippers G0 version (with external vacuum generator), can be mounted on all types of automated or robotic systems, via M8 spacers, sliding in the grooves of the aluminum profile.

- CVGL 424 and 624: 4 x M8 spacers.
- CVGL 824: 6 x M8 spacers.

Dimensions

	CVGL424	CVGL624	CVGL824
A	424	624	824
B	408	608	808

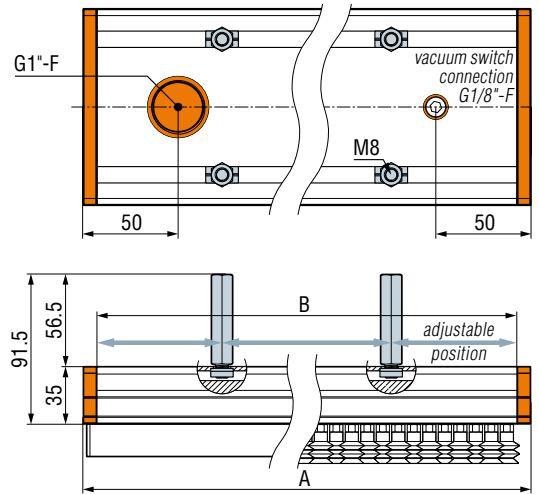
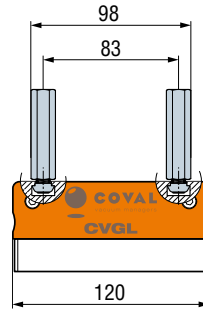

D1 or D2 versions, without control

(1 integrated vacuum generator, CMS HDE series).

The COVAL CVGL series vacuum grippers, D1 and D2 versions, are mounted on all types of automated systems via M8 spacers pre-installed on sliding nuts.

- CVGL 424 and 624: 4 x M8 spacers.
- CVGL 824: 8 x M8 spacers.

Dimensions

	CVGL424	CVGL624	CVGL824
A	424	624	824
B	408	608	808
C	15	134	233
D	125	207	307
E	76	194	294
F	116	198	298

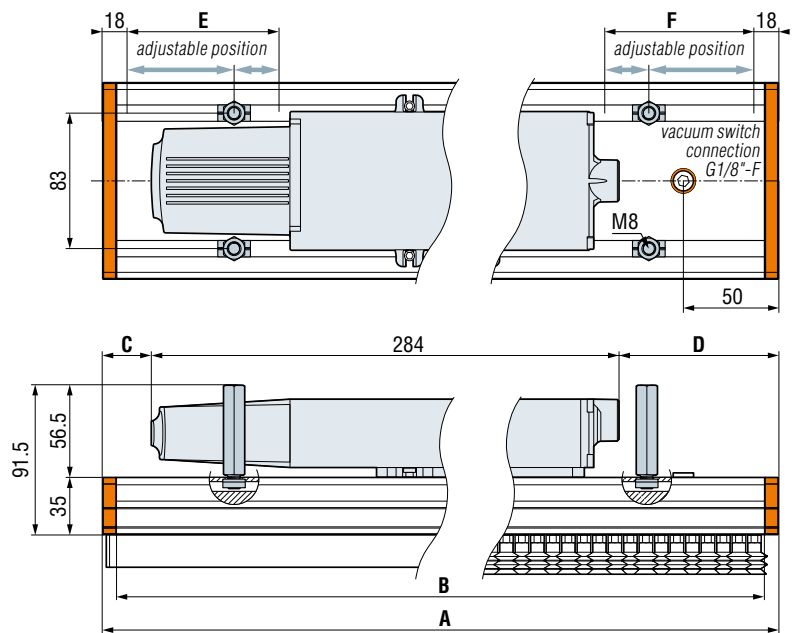
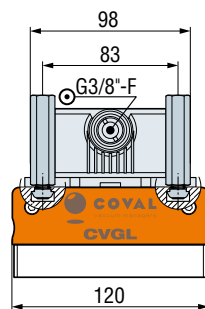

You can access 3D files of all our products in formats compatible with the main CAD software on our website
www.coval.com

Note: all dimensions are in mm.



D1 or D2 versions, with control

(1 integrated vacuum generator, CMS HDE series).

The COVAL CVGL series vacuum grippers, D1 and D2 versions, are mounted on all types of automated systems via M8 spacers pre-installed on sliding nuts.

- CVGL 424 and 624: 4 x M8 spacers.
- CVGL 824: 8 x M8 spacers.

Dimensions

	CVGL424	CVGL624	CVGL824
A	424	624	824
B	408	608	808
C	15	134	234
D	78	160	260
E	76	194	294
F	47	129	229

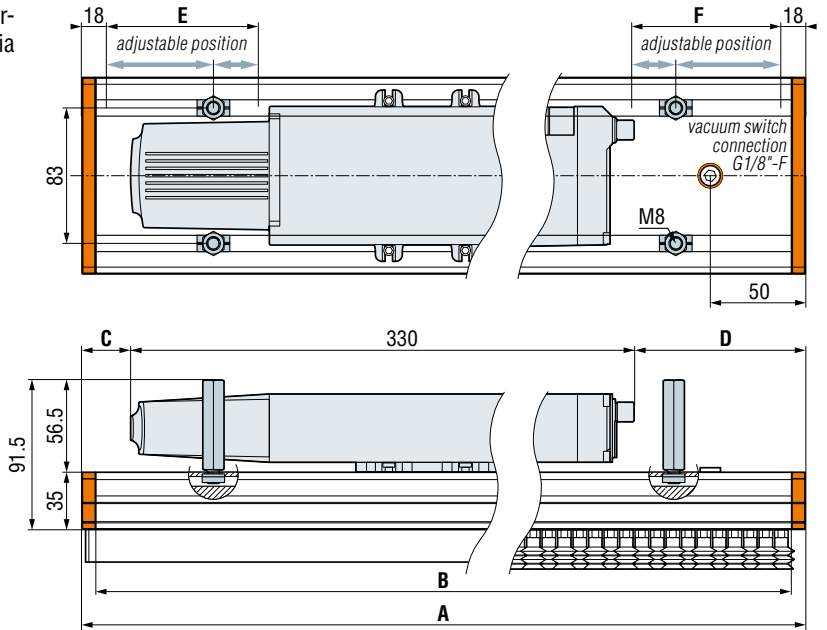
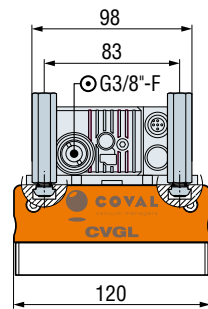

D3 versions

(2 integrated vacuum generators, CMS HDE series).

The CVGL vacuum grippers, D3 version, utilizes adjustable M8 spacers.

- CVGL 824: 6 x M8 spacers.

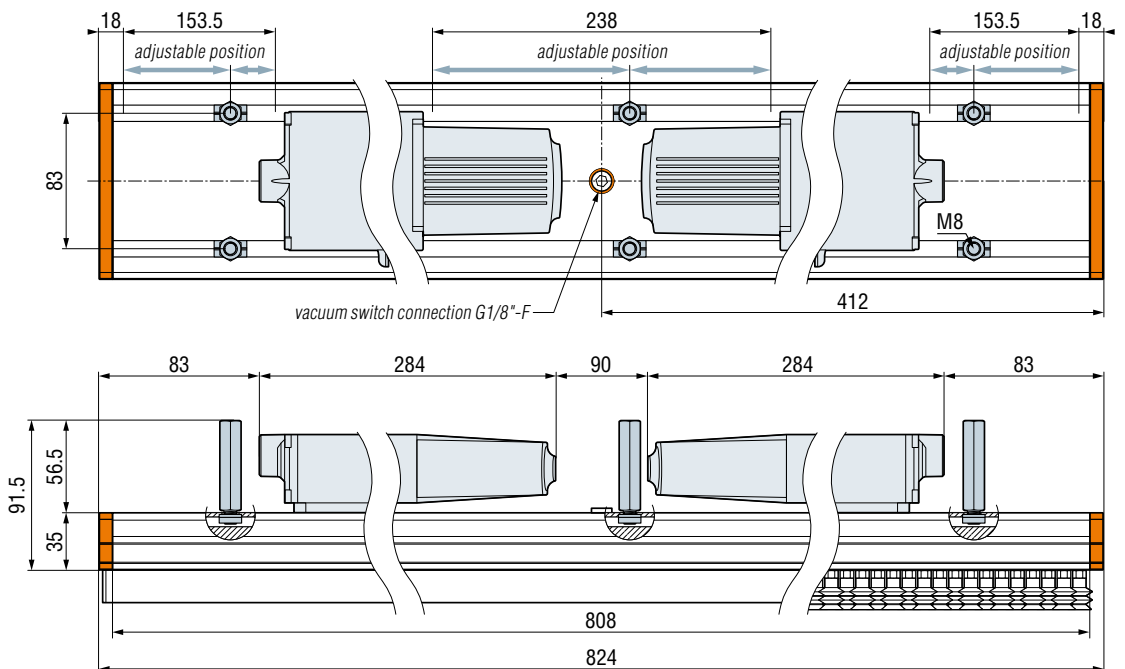
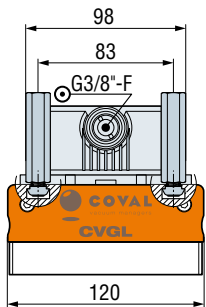

Note: all dimensions are in mm.



CVGL Series with Suction Cup Gripping Interface

"MINI" type suction cup gripping interface

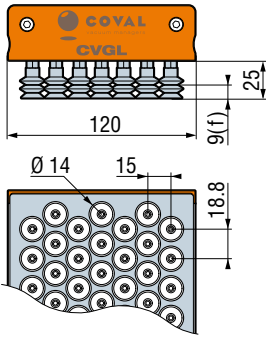

"MEDIUM" type suction cup gripping interface

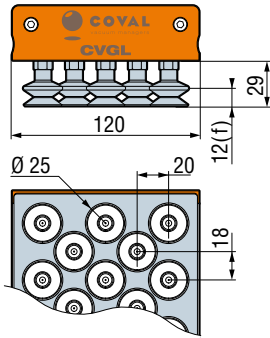

f: suction cup deflection

"MAXI" type suction cup gripping interface, STRAIGHT PATTERN

model VSA33

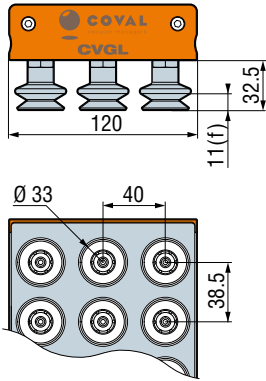

model MVS30

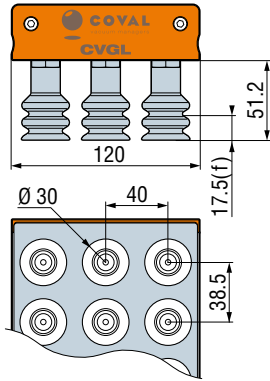

"MAXI" type suction cup gripping interface, STAGGERED PATTERN

model VSA33

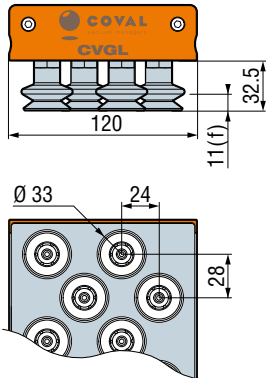

model MVS30

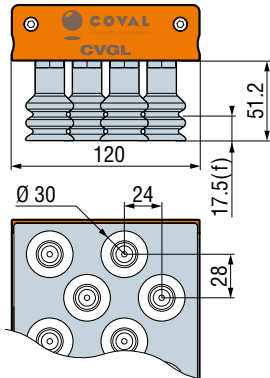

NUMBER OF SUCTION CUPS PER GRIPPING INTERFACE

	CVGL424	CVGL624	CVGL824
"Mini" type suction cup Ø14 mm (Ø16 mm max.)	150	220	297
"Medium" type suction cup Ø25 mm (Ø18 to 25 mm)	55	83	113
"Maxi" type, STRAIGHT pattern Ø30 or Ø33 mm suction cups (Ø36 mm max.)	33	48	63
"Maxi" type, STAGGERED pattern Ø30 or Ø33 mm suction cups (Ø36 mm max.)	28	42	58

CVGL Series with Foam Gripping Interface

"MINI" type foam gripping interface

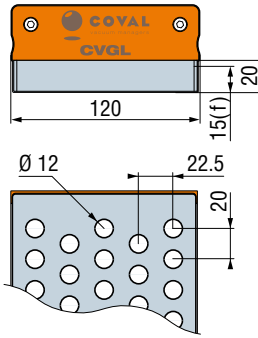

"MAXI" type foam gripping interface

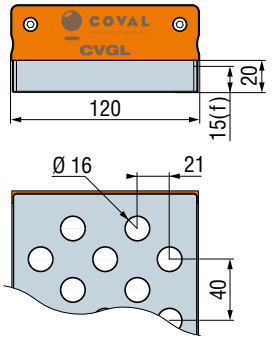

f: foam compression

NUMBER OF GRIPPING POINTS PER INTERFACE

	CVGL424	CVGL624	CVGL824
"mini" type gripping interface Ø12 mm	98	148	198
"maxi" type gripping interface Ø16 mm	50	75	100

CVGL Series with "COVAL-flex" Gripping Interface

COVAL-flex

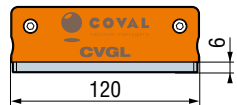

Option: quick installation of the interface

Option: CVGL ___ **C** quick installation of the interface via spring clips

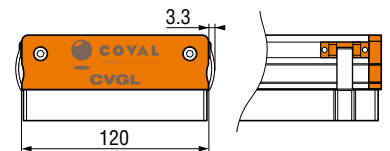

Option: HMI mounted on the vacuum generator

Option: CVGL ___ **VI**

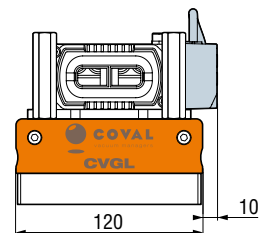

Note: all dimensions are in mm.



General Characteristics

- Temperature: from 0 to 50°C (32 to 122° F).
- Material of the gripper: aluminum, PA 6.6 15% GF, brass, stainless steel, neoprene.
- Foam gripping interface material: EPDM.
- Suction cup gripping interface materials:
 - "mini" type interface: silicone 30 Shore.
 - "medium" type interfaces: natural rubber 50 Shore.
 - "maxi" type interfaces: natural rubber 50 Shore or white silicone 35 Shore.

Multi-stage Vacuum Pumps General Characteristics

- Supply: non-lubricated air, filtered to 5 microns, according to standard ISO 8573-1:2010 [3:4:4]
- Operating pressure: from 2 to 8 bar
- Optimal dynamic pressure:
 - CMSHDE_NVO (for CVGL_GON_ grippers) without control: 5.5 bar.
 - CMSHDE_S_ / CMSHDE_V_ with control (for CVGL_S_ / CVGL_V_ grippers): 6 bar.
- Pressure connection: G3/8"-F with removable 350 µm filter screen
- Max. vacuum: 80%
- Air suction flow rate: 700 to 2200 NI/min
- Air consumption: 220 to 840 NI/min
- Noise level:
 - CMSHDE90X50_K : 59 dBA
 - CMSHDE90X100_K : 62 dBA
- Degree of protection: IP65
- Max. operating frequency: 4 Hz
- Endurance: 50 million cycles
- Materials: PA GF, brass, aluminum, steel, NBR, PU, FKM
- M12 and M8 male connectors (depending on version)

Integrated electronics

- 24 V DC power supply (regulated ±10%)
- Inputs/outputs protected against reversed wiring and polarity
- Consumption: 170 mA max. (without load)

Only on models CMSHDE_VX_ installed on CVGL_S2 / V2:

- Vacuum measuring range: 0 to 99%
- Pressure measuring range: 0 to 10 bar
- Vacuum and pressure measurement accuracy: ±1.5% of the range, compensated for temperature
- Input/Output switching mode: PNP or PNP/NPN configurable
- Digital inputs/outputs mode (SIO) / IO-Link

DO1 output signal

Only on models CMSHDE_VX_ installed on CVGL_S2 / V2:

- Configurable as PNP or NPN
- NO or NC
- Breaking capacity: 330 mA
- DO1: object gripped output (factory setting 40%)

Diagnostics

Only on models CMSHDE_VX_ installed on CVGL_S2 / V2:

- Instantaneous vacuum level (unit transmitted over IO-Link: mbar)
- Available information: Object gripped, object lost
- Cycle counters (vacuum, blow-off, object gripped, object lost, etc.)
- Supply pressure monitoring

- Supply voltage monitoring
- Product part number and serial number
- Software version

Indicator

Only on models CMSHDE_VOC15P_ installed on CVGL_S1 / V1:

- Status LED for control functions:
 - Green LED: vacuum control
 - Orange LED: blow-off control

Information displayed on HMI (VI option)

- LED gripping status indicator on front panel (Green: object gripped, Red: object lost)
- 1.54" high-visibility color LCD display:
 - Displays vacuum level with bar graph and thresholds
 - Warns when service life has been exceeded (> 50 million cycles)
 - Explicit fault messages
 - "Suction cup" icon indicating the status of control functions:
 - Green suction cup: vacuum control
 - Orange suction cup: blow-off control
 - Red suction cup: simultaneous vacuum and blow-off control
 - Configurable display orientation: 0 - 90 - 180 - 270°

Parameter settings available with the HMI or IO-Link

Only on models CMSHDE_VX_ installed on CVGL_S2 / V2:

- Choice of blow-off type (CVGL_S2 only):
 - Controlled
 - Automatic timed, adjustable from 50 to 9999 ms
- Object gripped (L1) control thresholds
- Whenever required by the application, specific threshold and hysteresis settings that are different from the initial factory settings can be defined: L1 = 40%, h1 = 10%

+ Additional settings available with the HMI

(performed with 4-key membrane keyboard):

- Choice of language: EN, FR, DE, IT, or ES
- Choice of vacuum measurement unit (kPa, %, mbar, inHg)
- Choice of pressure measurement unit (MPa, bar, psi)
- Monostable electrical manual controls

Communication

IO-Link

- Revision: 1.1
- Transmission rate: COM3 - 230.4 kbit/s
- Min. cycle time: 1 ms
- SIO mode: Yes
- Process Data Input (PDI): 6 bytes
- Process Data Output (PDO): 1 byte
- IO device description file (IODD) available for download

NFC

- COVAL VACUUM MANAGER Mobile app available:
 - Android, version 8.1 and higher
 - iOS, version 13 and higher



COVAL
vacuum managers

vacuum
components



A TECHNOLOGICAL PARTNER ON A GLOBAL SCALE

Located in the southeast region of France, COVAL conceives, manufactures and globally distributes high performance, advanced vacuum automation components and systems for industrial applications in all branches.

COVAL is an ISO 9001: V2015 certified company which offers innovative solutions integrating reliable and optimized components with intelligent functionalities. The focus is to provide the most personalized and economic solution to a given application while assuring a significant improvement in the productivity and the safety for the vacuum users around the world.

COVAL has an ambition for technical excellence and innovation. As a specialist in vacuum automation, COVAL is reputed for offering reliable, personalized, cost effective and productive solutions.

The references of COVAL can be found in several industrial sectors (Packaging, Automotive Industry, Plastic, Graphic, Aeronautic...) where vacuum handling is important for high efficiency and productivity.

COVAL markets its products and services all over Europe, in the United States and South America through its subsidiaries and authorized distribution network. COVAL strives to provide customer driven solutions and gives the best possible treatment to satisfy all its clients.

For all enquiries from Australia, Africa and Asia kindly contact COVAL head office in France.



COVAL S.A.S.
Head Office



COVAL INC.



COVAL IBERICA



COVAL GERMANY



COVAL ITALIA



COVAL CHINA

Distributed by:



COVAL S.A.S.
Head Office
ZA Les Petits Champs
10 allée Jean-Baptiste Venturi
26120 Montélier France
Tel : +33 (0)4 75 59 91 91
Fax : +33 (0)4 75 59 91 05

www.coval.com