

# M--C - MD

## Air Amplifiers

### Applications



#### BLOW-OFF, CLEANING, WASTE SUCTION

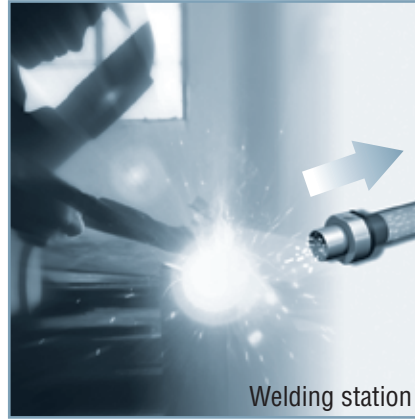
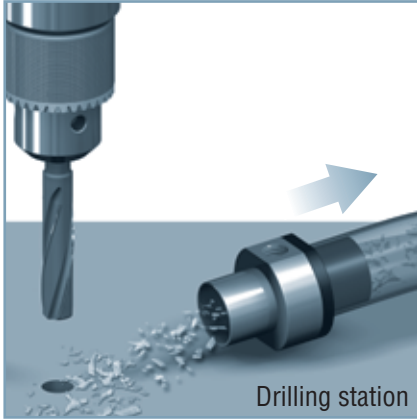

#### SORTING BY WEIGHT

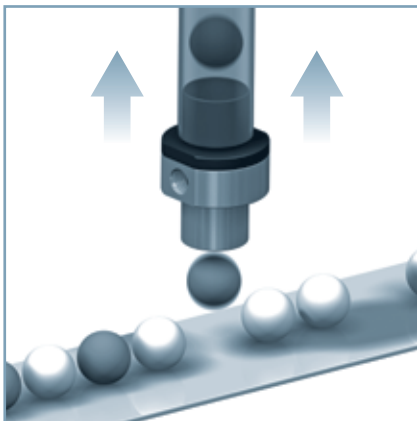

#### TRANSPORT OF GRANULES (rice, grains of wheat or coffee, etc.)

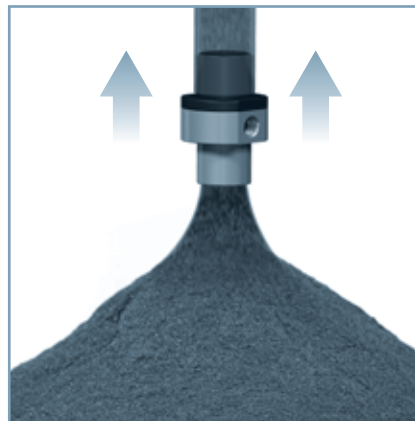

#### DEGASSING, SMOKE EVACUATION

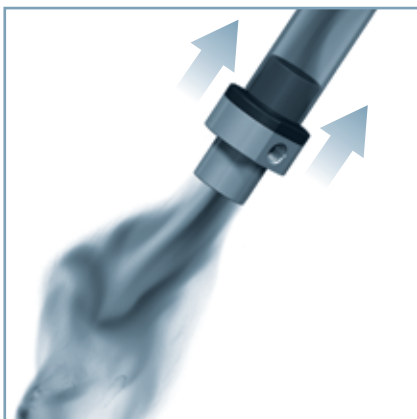

#### GRIPPING AND / OR UNSTACKING VERY POROUS LOADS

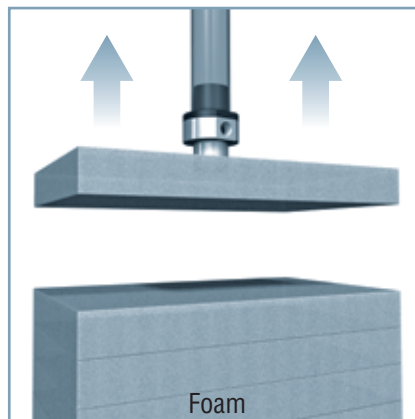

# M--C

## Air Amplifiers



By virtue of the COANDA effect, the motor flux draws in air at room temperature. This physical phenomenon greatly amplifies the flow which results in very high suction produced with low consumption.

- Gripping of very porous, lightweight products: foam, carpet, cakes, leather, etc.
- Transport of powdery materials: powders, granules, etc.
- Transporting small, lightweight objects: paper clips, rice, coffee, etc.
- Smoke evacuation, chamber depressurization, etc.

### Operation requirement

Compressed air filtration at 5 microns for the M6C model and 20 microns for the other models.

### Characteristics

	L	N	M	C.A.	ØD	ØD1	ØD2	⚖ (g)
<b>M 6 C</b>	77	27.5	37	G1/8"-F	39	20	6	100
<b>M 10 C</b>	60	20	36	G1/8"-F	40	25	10	100
<b>M 20 C</b>	90	30	55	G1/4"-F	60	40	20	295
<b>M 30 CV</b>	105	35	72	G1/4"-F	77	50	30	495
<b>M 40 CV</b>	112	40	86	G3/8"-F	92	60	40	600

Note: all dimensions are shown in (mm).

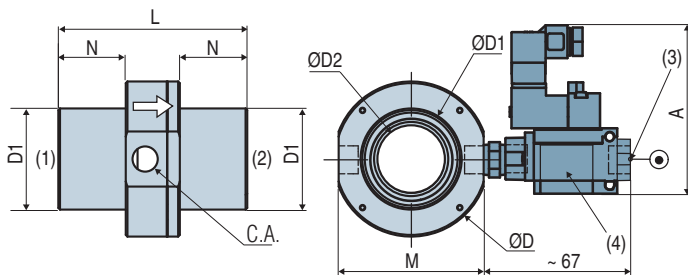

- (1) Suction
  - (2) Discharge
  - (3) G1/4"-F
  - (4) Control valve, optional. Note: the valve is incompatible with the M40C model.
- A = 77 mm for an AP2 valve + DIN connection (connector supplied)

### Specifications

<b>Compressed air</b>	Dry non-lubricated 1.5 to 5 bar
<b>Maximum pressure drop</b>	see table page 9/4
<b>Materials</b>	Aluminum body
<b>Temperature</b>	32 to 176°F

### Additional information

- Stainless steel versions are available on request.
- The 5 products present the best amplification ratio (consumption/suction). COVAL can study smaller amplification ratios (higher consumption) but higher maximum vacuum for transporting heavy objects.



### For all orders, please specify:

Model + bore Ø + C.A. control + C.A. fitting + valve controls

Example : M30CVAP214E1

1: Model	2: Bore Ø	3: C.A. controls	4: Valve controls	
<b>M</b>	<b>6 C</b>	6 mm	-	
	<b>10 C</b>	10 mm		Without control valve
	<b>20 C</b>	20 mm	AP214	C.A. control valve
	<b>30 CV</b>	30 mm		
	<b>40 CV</b>	40 mm		
			<b>P1</b> Pneumatic	
			<b>E1</b> 24 V DC DIN	

# M--C

## Air Amplifiers

### Performance Curves



#### Maximum Vacuum / Supply Pressure

	Supply pressure / Maximum vacuum (in Bar) (in mm CE)			
	2	3	4	5
<b>M 6 C</b>	900	1500	2000	2600
<b>M 10 C</b>	200	500	700	1000
<b>M 20 C</b>	207	310	400	510
<b>M 30 CV</b>	90	130	220	280
<b>M 40 CV</b>	140	200	284	360

#### Maximum Overpressure / Supply Pressure

	Supply pressure / Maximum Overpressure (in Bar) (in mm CE)			
	2	3	4	5
<b>M 6 C</b>	100	550	1300	2000
<b>M 10 C</b>	400	700	1500	2000
<b>M 20 C</b>	220	340	500	600
<b>M 30 CV</b>	45	70	100	160
<b>M 40 CV</b>	96	145	199	290

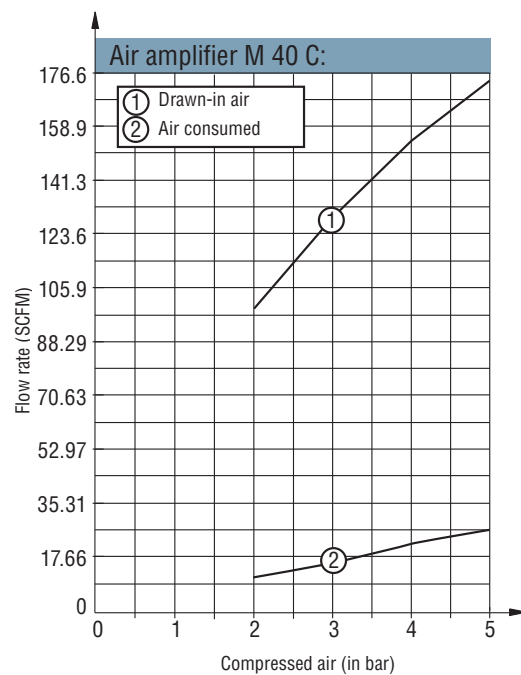
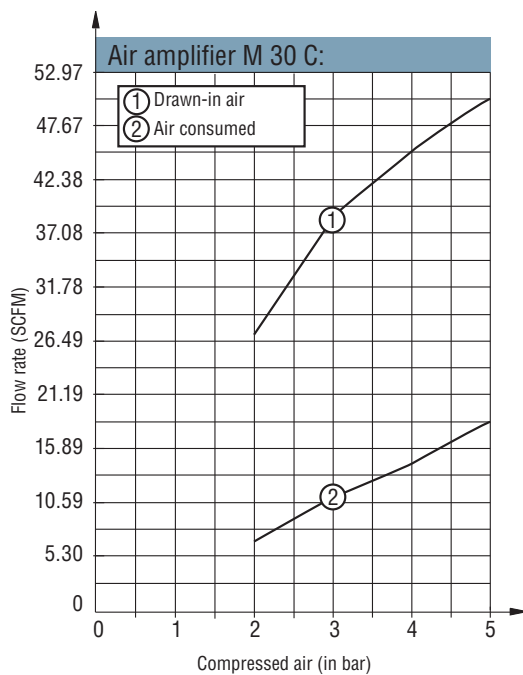
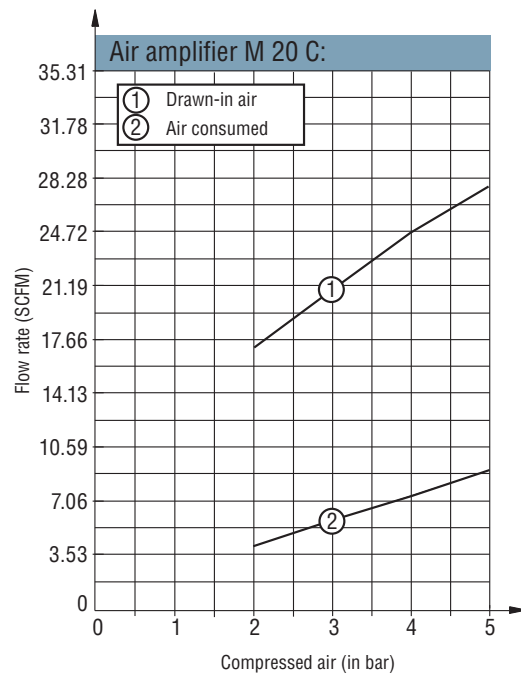
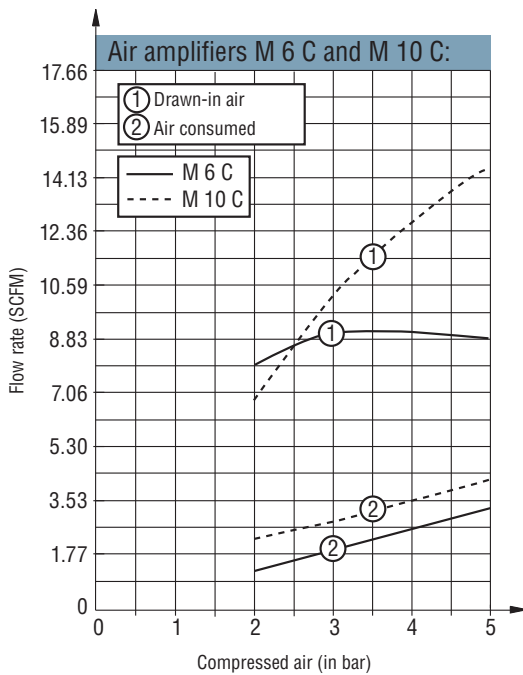

M--C 9