

VP

Flat Suction Cups Ø 8 to 75 mm



VP series flat suction cups are specially recommended for handling flat, rigid, smooth products.

- High tensile force
- High resistance to lateral forces enabling vertical handling.
- High degree of precision

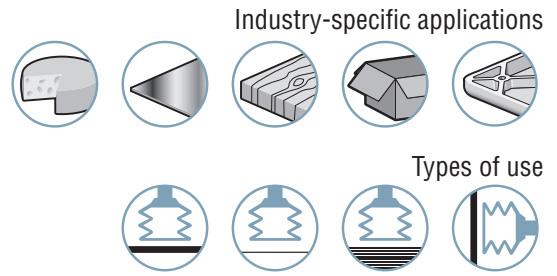

2
VP

Materials

- | | | | |
|------------|----------------|-------------|----------------------|
| NBR | Nitrile | SIT5 | Translucent silicone |
| NR | Natural rubber | STN | SITON® |

Suction Cup Properties

	Ø (mm)	(cm ³)	(lbf) ⁽¹⁾	(lbf) ⁽¹⁾	R _{min} (mm)	NBR	SIT5	NR	STN
VP 8	7.5	0.04	0.24	0.12	10	VP8NBR	VP8SIT5	-	VP8STN
VP 10	10	0.05	0.36	0.18	13	VP10NBR	VP10SIT5	-	-
VP 15	15	0.18	0.83	0.41	13	VP15NBR	VP15SIT5	-	VP15STN
VP 20	20	0.44	1.38	0.68	20	VP20NBR	VP20SIT5	-	VP20STN
VP 25	25	0.7	2.11	1.06	25	VP25NBR	VP25SIT5	-	VP25STN
VP 26	26	1.5	2.52	1.25	35	VP26NBR	VP26SIT5	-	-
VP 30	30	2.9	3.57	1.79	40	VP30NBR	VP30SIT5	-	VP30STN
VP 35	35	2.7	5.20	2.60	50	VP35NBR	VP35SIT5	-	-
VP 40	40	4	6.01	3.00	50	VP40NBR	VP40SIT5	VP40NR	VP40STN
VP 50	52	7	8.60	4.30	75	VP50NBR	VP50SIT5	-	VP50STN
VP 60	60	7.3	12.99	6.49	100	VP60NBR	VP60SIT5	-	-
VP 75	75	16	22.73	11.36	130	VP75NBR	VP75SIT5	VP75NR	-

(1) Actual force of the suction cup in use with 65% vacuum and including a safety factor of 2 for horizontal handling and a factor of 4 for vertical handling.

Choice of Fittings

(Ø)	Group	M5-M	M6-M	M8-M	M10-M	G1/8"-F	G1/8"-M	10/32-M	G1/4"-F	G1/4"-M	G3/8"-M	G1/2"-M
8...25	1	■	■	-	-	■	■	□	-	-	-	-
26...60	2	□	□	□	□	■	■	-	■	■	-	-
75	3	-	-	-	□	-	■	-	■	■	■	□

■ Standard available configurations (suction cup + fitting) refer to page 2/4
 □ Additional mounting configurations see page 2/7

Fitting: M = male F = female

Types of Assembly

COVAL suction cups can be assembled in a wide variety of configurations.



Version C: Barbed fitting



Version S: Factory-crimped fitting



Version V: Removable fitting:
(adapter and hollow screw)

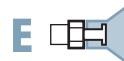

Version E: Pressed fitting







Please specify the part n°. e.g. VP40STNIM14C
 Refer to page 2/4



Accessories

To optimize the use of your suction cups, Coval offers a comprehensive range of accessories (feelers, nozzle fittings, spring extensions, and feeder systems, etc.), see chapters 4 and 14.



Group 1		C 			
THREAD		M5-M	M6-M	G1/8"-M	G1/8"-F
Ø 8 - 25 mm	VP8NBR	VP8NBRIMM5C	VP8NBRIMM6C	VP8NBRIM18C	VP8NBRIF18C
	VP8SIT5	VP8SIT5IMM5C	VP8SIT5IMM6C	VP8SIT5IM18C	VP8SIT5IF18C
	VP8STN	VP8STNIMM5C	VP8STNIMM6C	VP8STNIM18C	VP8STNIF18C
	VP10NBR	VP10NBRIMM5C	VP10NBRIMM6C	VP10NBRIM18C	VP10NBRIF18C
	VP10SIT5	VP10SIT5IMM5C	VP10SIT5IMM6C	VP10SIT5IM18C	VP10SIT5IF18C
	VP15NBR	VP15NBRIMM5C	VP15NBRIMM6C	VP15NBRIM18C	VP15NBRIF18C
	VP15SIT5	VP15SIT5IMM5C	VP15SIT5IMM6C	VP15SIT5IM18C	VP15SIT5IF18C
	VP15STN	VP15STNIMM5C	VP15STNIMM6C	VP15STNIM18C	VP15STNIF18C
	VP20NBR	VP20NBRIMM5C	VP20NBRIMM6C	VP20NBRIM18C	VP20NBRIF18C
	VP20SIT5	VP20SIT5IMM5C	VP20SIT5IMM6C	VP20SIT5IM18C	VP20SIT5IF18C
	VP20STN	VP20STNIMM5C	VP20STNIMM6C	VP20STNIM18C	VP20STNIF18C
	VP25NBR	VP25NBRIMM5C	VP25NBRIMM6C	VP25NBRIM18C	VP25NBRIF18C
	VP25SIT5	VP25SIT5IMM5C	VP25SIT5IMM6C	VP25SIT5IM18C	VP25SIT5IF18C
	VP25STN	VP25STNIMM5C	VP25STNIMM6C	VP25STNIM18C	VP25STNIF18C

Group 2		C 		E 		V 			
THREAD		G1/4"-M	G1/4"-F	G1/4"-M	G1/4"-F	G1/8"-M	G1/8"-F	G1/4"-M	G1/4"-F
Ø 26 - 60 mm	VP26NBR	VP26NBRIM14C	VP26NBRIF14C	VP26NBRIM14	VP26NBRIF14	VP26NBRIM18V	VP26NBRIF18V	VP26NBRIM14V	VP26NBRIF14V
	VP26SIT5	VP26SIT5IM14C	VP26SIT5IF14C	VP26SIT5IM14	VP26SIT5IF14	VP26SIT5IM18V	VP26SIT5IF18V	VP26SIT5IM14V	VP26SIT5IF14V
	VP30NBR	VP30NBRIM14C	VP30NBRIF14C	VP30NBRIM14	VP30NBRIF14	VP30NBRIM18V	VP30NBRIF18V	VP30NBRIM14V	VP30NBRIF14V
	VP30SIT5	VP30SIT5IM14C	VP30SIT5IF14C	VP30SIT5IM14	VP30SIT5IF14	VP30SIT5IM18V	VP30SIT5IF18V	VP30SIT5IM14V	VP30SIT5IF14V
	VP30STN	VP30STNIM14C	VP30STNIF14C	VP30STNIM14	VP30STNIF14	VP30STNIM18V	VP30STNIF18V	VP30STNIM14V	VP30STNIF14V
	VP35NBR	VP35NBRIM14C	VP35NBRIF14C	VP35NBRIM14	VP35NBRIF14	VP35NBRIM18V	VP35NBRIF18V	VP35NBRIM14V	VP35NBRIF14V
	VP35SIT5	VP35SIT5IM14C	VP35SIT5IF14C	VP35SIT5IM14	VP35SIT5IF14	VP35SIT5IM18V	VP35SIT5IF18V	VP35SIT5IM14V	VP35SIT5IF14V
	VP40NBR	VP40NBRIM14C	VP40NBRIF14C	VP40NBRIM14	VP40NBRIF14	VP40NBRIM18V	VP40NBRIF18V	VP40NBRIM14V	VP40NBRIF14V
	VP40NR	VP40NRIM14C	VP40NRIF14C	VP40NRIM14	VP40NRIF14	VP40NRIM18V	VP40NRIF18V	VP40NRIM14V	VP40NRIF14V
	VP40SIT5	VP40SIT5IM14C	VP40SIT5IF14C	VP40SIT5IM14	VP40SIT5IF14	VP40SIT5IM18V	VP40SIT5IF18V	VP40SIT5IM14V	VP40SIT5IF14V
	VP40STN	VP40STNIM14C	VP40STNIF14C	VP40STNIM14	VP40STNIF14	VP40STNIM18V	VP40STNIF18V	VP40STNIM14V	VP40STNIF14V
	VP50NBR	VP50NBRIM14C	VP50NBRIF14C	VP50NBRIM14	VP50NBRIF14	VP50NBRIM18V	VP50NBRIF18V	VP50NBRIM14V	VP50NBRIF14V
	VP50SIT5	VP50SIT5IM14C	VP50SIT5IF14C	VP50SIT5IM14	VP50SIT5IF14	VP50SIT5IM18V	VP50SIT5IF18V	VP50SIT5IM14V	VP50SIT5IF14V
	VP50STN	VP50STNIM14C	VP50STNIF14C	VP50STNIM14	VP50STNIF14	VP50STNIM18V	VP50STNIF18V	VP50STNIM14V	VP50STNIF14V
	VP60NBR	VP60NBRIM14C	VP60NBRIF14C	VP60NBRIM14	VP60NBRIF14	VP60NBRIM18V	VP60NBRIF18V	VP60NBRIM14V	VP60NBRIF14V
	VP60SIT5	VP60SIT5IM14C	VP60SIT5IF14C	VP60SIT5IM14	VP60SIT5IF14	VP60SIT5IM18V	VP60SIT5IF18V	VP60SIT5IM14V	VP60SIT5IF14V

Group 3		V 			S 		
THREAD		G1/8"-M	G1/4"-M	G1/4"-F	G1/4"-M	G1/4"-F	G3/8"-M
Ø 75 mm	VP75NBR	VP75NBRIM18V	VP75NBRIM14V	VP75NBRIF14V	VP75NBRIM14	VP75NBRIF14	VP75NBRIM38
	VP75NR	VP75NRIM18V	VP75NRIM14V	VP75NRIF14V	VP75NRIM14	VP75NRIF14	VP75NRIM38
	VP75SIT5	VP75SIT5IM18V	VP75SIT5IM14V	VP75SIT5IF14V	VP75SIT5IM14	VP75SIT5IF14	VP75SIT5IM38

Additional mounting configurations are available (see page 2/7).
For standard configurations (suction cup+fitting), the C and V versions are delivered unassembled.

VP

Flat Suction Cups Ø 8 to 75 mm

Dimensions "Suction Cup + Fitting"



VP 2

VP 8 - 10 Group 1

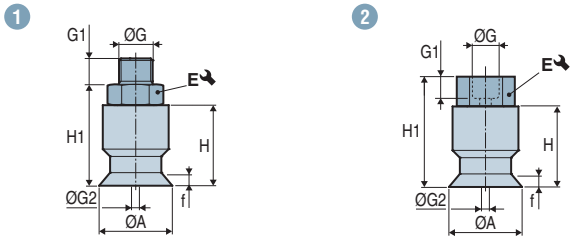

VP 15 - 25 Group 1

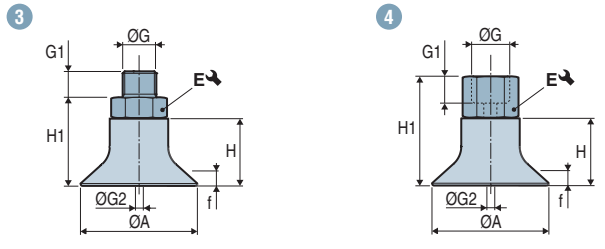

VP 26 - 60 Group 2

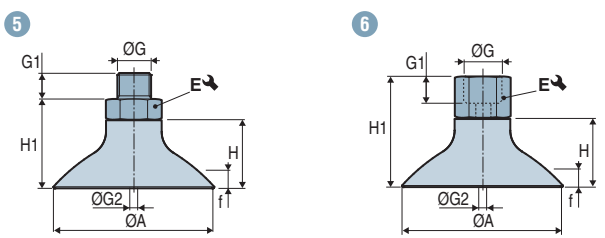

VP 75 Group 3

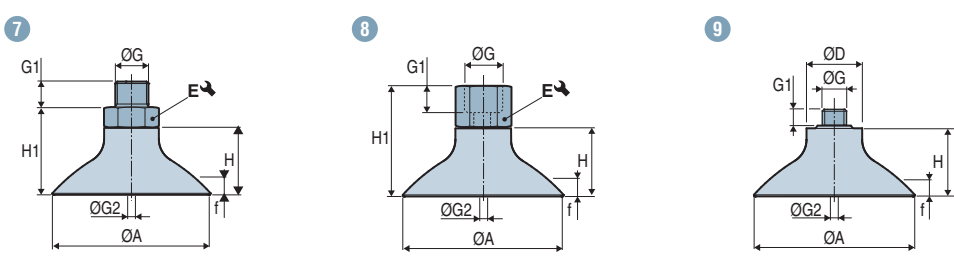

Group 1	Diagram	ØA	ØD	f ⁽¹⁾	H	H1	ØG	G1	ØG2 ⁽²⁾	E ↘	⊖ (g)	
Ø 8 - 25 mm	VP8---IMM5C	1	7.5	-	1.3	10	15	M5-M	4.5	2.5	7	3.5
	VP8---IMM6C	1	7.5	-	1.3	10	15	M6-M	5	3.5	7	3.1
	VP8---IM18C	1	7.5	-	1.3	10	16	G1/8"-M	7.5	3.5	14	4.5
	VP8---IF18C	2	7.5	-	1.3	10	22	G1/8"-F	8	3.5	14	4.4
	VP10---IMM5C	1	10	-	1.5	10.5	15.5	M5-M	4.5	2.5	7	3.6
	VP10---IMM6C	1	10	-	1.5	10.5	15.5	M6-M	5	3.5	7	3.2
	VP10---IM18C	1	10	-	1.5	10.5	16.5	G1/8"-M	7.5	3.5	14	4.6
	VP10---IF18C	2	10	-	1.5	10.5	22.5	G1/8"-F	8	3.5	14	4.5
	VP15---IMM5C	3	15	-	2.25	11	16	M5-M	4.5	2.5	7	3.8
	VP15---IMM6C	3	15	-	2.25	11	16	M6-M	5	3.5	7	3.4
	VP15---IM18C	3	15	-	2.25	11	17	G1/8"-M	7.5	3.5	14	4.8
	VP15---IF18C	4	15	-	2.25	11	23	G1/8"-F	8	3.5	14	4.7
	VP20---IMM5C	3	20	-	3	11.5	16.5	M5-M	4.5	2.5	7	4.2
	VP20---IMM6C	3	20	-	3	11.5	16.5	M6-M	5	3.5	7	3.8
	VP20---IM18C	3	20	-	3	11.5	17.5	G1/8"-M	7.5	3.5	14	5.2
	VP20---IF18C	4	20	-	3	11.5	23.5	G1/8"-F	8	3.5	14	5.1
	VP25---IMM5C	3	25	-	3	12	17	M5-M	4.5	2.5	7	4.6
	VP25---IMM6C	3	25	-	3	12	17	M6-M	5	3.5	7	4.2
	VP25---IM18C	3	25	-	3	12	18	G1/8"-M	7.5	3.5	14	5.6
	VP25---IF18C	4	25	-	3	12	24	G1/8"-F	8	3.5	14	5.5

Note: All dimensions are in mm

(1) f = Deflection of the suction cup. (2) Ø G2 = Ø internal orifice of the fitting.



Group 2	Diagram	ØA	ØD	f ⁽¹⁾	H	H1	ØG	G1	ØG2 ⁽²⁾	E ↘	⊞ (g)	
Ø 26 - 60 mm	VP26---IM18V	5	26	-	3	19.5	24	G1/8"-M	6	3.5	13	17.9
	VP26---IF18V	6	26	-	3	19.5	32.5	G1/8"-F	7.5	3.5	13	21.2
	VP26---IM14	5	26	-	3	19.5	23.5	G1/4"-M	11	4.4	17	11.6
	VP26---IM14C	5	26	-	3	19.5	27.5	G1/4"-M	10	7	17	12.5
	VP26---IM14V	5	26	-	3	19.5	24.5	G1/4"-M	8	3.5	17	27.2
	VP26---IF14	6	26	-	3	19.5	34.5	G1/4"-F	10	4.4	17	12.2
	VP26---IF14C	6	26	-	3	19.5	34.5	G1/4"-F	12	6.9	17	11.8
	VP26---IF14V	6	26	-	3	19.5	35.5	G1/4"-F	11	3.5	17	31.8
	VP30---IM18V	5	30	-	2.5	19	23.5	G1/8"-M	6	3.5	13	17.3
	VP30---IF18V	6	30	-	2.5	19	32	G1/8"-F	7.5	3.5	13	21.6
	VP30---IM14	5	30	-	2.5	19	23	G1/4"-M	11	4.4	17	12.0
	VP30---IM14C	5	30	-	2.5	19	27	G1/4"-M	10	7	17	12.9
	VP30---IM14V	5	30	-	2.5	19	24	G1/4"-M	8	3.5	17	27.6
	VP30---IF14	6	30	-	2.5	19	34	G1/4"-F	10	4.4	17	12.6
	VP30---IF14C	6	30	-	2.5	19	34	G1/4"-F	12	6.9	17	12.2
	VP30---IF14V	6	30	-	2.5	19	35	G1/4"-F	11	3.5	17	32.2
	VP35---IM18V	5	35	-	3	20	24.5	G1/8"-M	6	3.5	13	20.1
	VP35---IF18V	6	35	-	3	20	33	G1/8"-F	7.5	3.5	13	23.4
	VP35---IM14	5	35	-	3	20	24	G1/4"-M	11	4.4	17	13.8
	VP35---IM14C	5	35	-	3	20	28	G1/4"-M	10	7	17	14.7
	VP35---IM14V	5	35	-	3	20	25	G1/4"-M	8	3.5	17	29.4
	VP35---IF14	6	35	-	3	20	35	G1/4"-F	10	4.4	17	14.4
	VP35---IF14C	6	35	-	3	20	35	G1/4"-F	12	6.9	17	14.0
	VP35---IF14V	6	35	-	3	20	36	G1/4"-F	11	3.5	17	34.0
	VP40---IM18V	5	40	-	3	20	24.5	G1/8"-M	6	3.5	13	20.6
	VP40---IF18V	6	40	-	3	20	33	G1/8"-F	7.5	3.5	13	23.9
	VP40---IM14	5	40	-	3	20	24	G1/4"-M	11	4.4	17	14.3
	VP40---IM14C	5	40	-	3	20	28	G1/4"-M	10	7	17	15.2
	VP40---IM14V	5	40	-	3	20	25	G1/4"-M	8	3.5	17	29.9
	VP40---IF14	6	40	-	3	20	35	G1/4"-F	10	4.4	17	14.9
VP40---IF14C	6	40	-	3	20	35	G1/4"-F	12	6.9	17	14.5	
VP40---IF14V	6	40	-	3	20	36	G1/4"-F	11	3.5	17	34.5	
VP50---IM18V	5	52	-	4.5	22	26.5	G1/8"-M	6	3.5	13	26.4	
VP50---IF18V	6	52	-	4.5	22	35	G1/8"-F	7.5	3.5	13	29.7	
VP50---IM14	5	52	-	4.5	22	26	G1/4"-M	11	4.4	17	20.1	
VP50---IM14C	5	52	-	4.5	22	30	G1/4"-M	10	7	17	21.0	
VP50---IM14V	5	52	-	4.5	22	27	G1/4"-M	8	3.5	17	35.7	
VP50---IF14	6	52	-	4.5	22	37	G1/4"-F	10	4.4	17	20.7	
VP50---IF14C	6	52	-	4.5	22	37	G1/4"-F	12	6.9	17	20.3	
VP50---IF14V	6	52	-	4.5	22	38	G1/4"-F	11	3.5	17	40.3	
VP60---IM18V	5	60	-	4.5	22	26.5	G1/8"-M	6	3.5	13	30.1	
VP60---IF18V	6	60	-	4.5	22	35	G1/8"-F	7.5	3.5	13	33.4	
VP60---IM14	5	60	-	4.5	22	26	G1/4"-M	11	4.4	17	23.8	
VP60---IM14C	5	60	-	4.5	22	30	G1/4"-M	10	7	17	24.7	
VP60---IM14V	5	60	-	4.5	22	27	G1/4"-M	8	3.5	17	39.4	
VP60---IF14	6	60	-	4.5	22	37	G1/4"-F	10	4.4	17	24.4	
VP60---IF14C	6	60	-	4.5	22	37	G1/4"-F	12	6.9	17	24.0	
VP60---IF14V	6	60	-	4.5	22	38	G1/4"-F	11	3.5	17	44.0	

Group 3

Ø 75 mm	VP75---IM18V	9	75	23	4.5	32	-	G1/8"-M	8	6	-	58.3
	VP75---IM14	7	75	-	4.5	32	38	G1/4"-M	11	8	21	46.4
	VP75---IM14V	7	75	-	4.5	32	37	G1/4"-M	8	6	17	68.9
	VP75---IF14	8	75	-	4.5	32	47	G1/4"-F	10	8	21	50.3
	VP75---IF14V	8	75	-	4.5	32	51	G1/4"-F	9	6	17	78.5
	VP75---IM38	7	75	-	4.5	32	43	G3/8"-M	11	8	21	47

Note: All dimensions are in mm

(1) f = Deflection of the suction cup. (2) Ø G2 = Ø internal orifice of the fitting.



2
VP

VP 8 - 25 Group 1

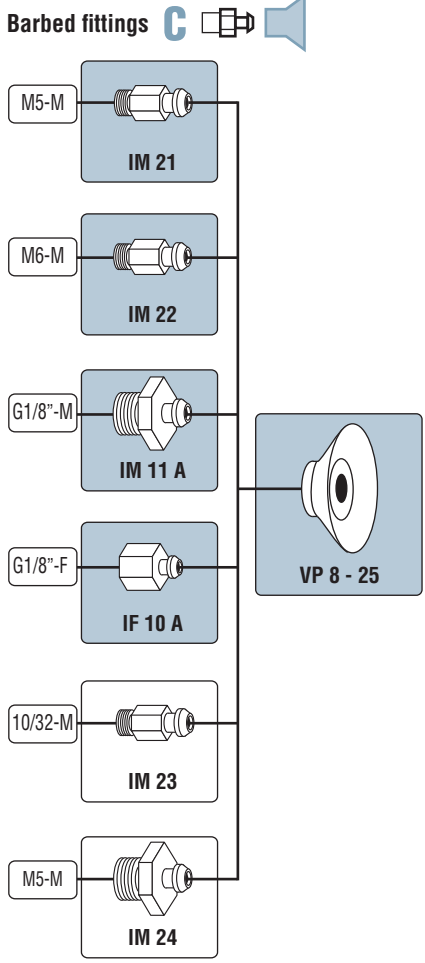

VP 26 - 60 Group 2

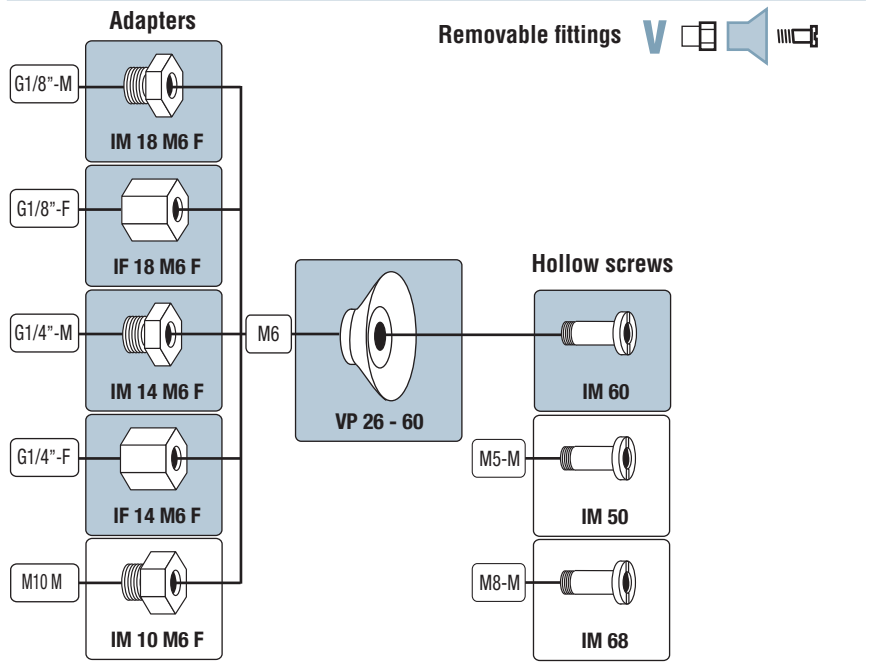
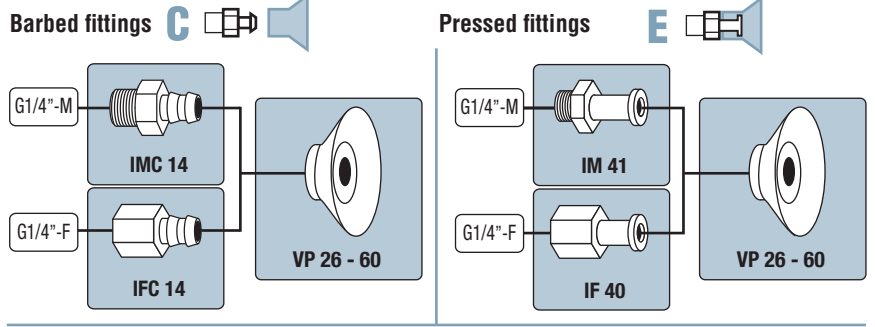

VP 75 Group 3

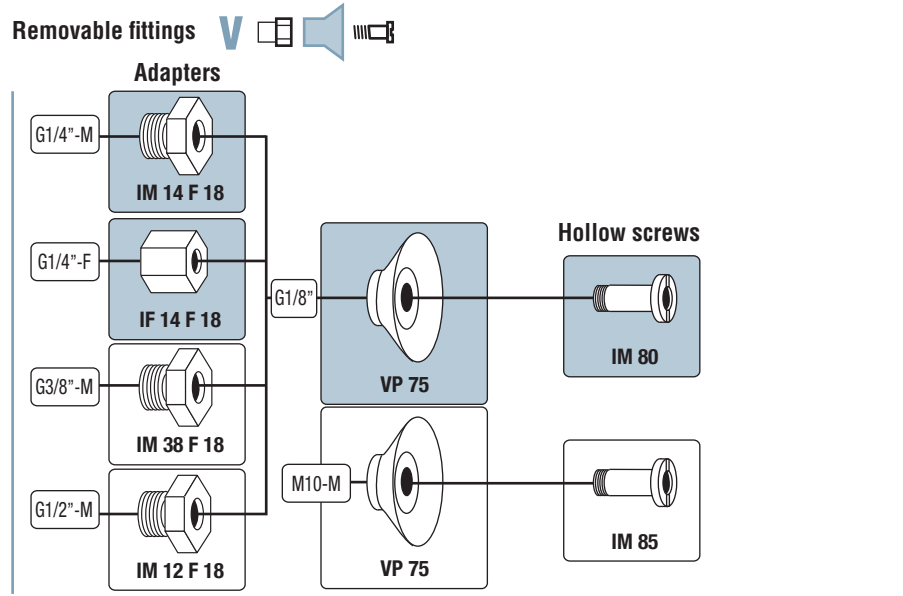
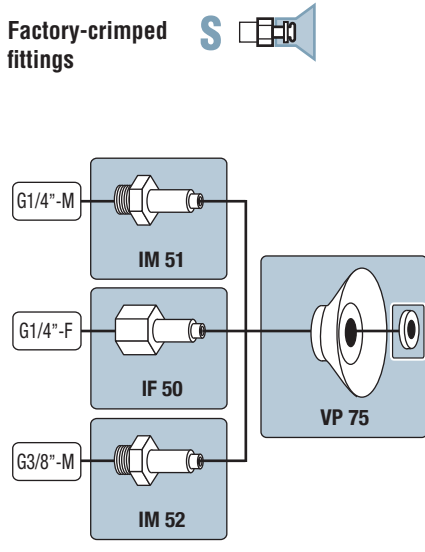

Configurations (suction cup + fitting) refer to page 2/4
 Non-standard configurations must be ordered in separate part numbers.

Fittings and suction cups dimensions: see page 2/8.



Suction Cups

VP 8... 10

VP 15... 25

VP 26... 75

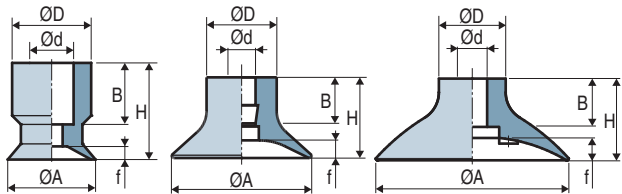

(1) f = Deflection of the suction cup.

VP	ØA	H	Ød	ØD	f (1)	B	⚖ (g)
VP 8	7.5	10	5	9	1.3	7	0.4
VP 10	10	10.5	4.4	9	1.5	7	0.5
VP 15	15	11	4	9	2.25	7	0.7
VP 20	20	11.5	4	10	3	7	1.2
VP 25	25	12	4	10	3	7	1.4
VP 26	26	19.5	8	16	3	13	3.7
VP 30	30	19	8	16	2.5	13	4
VP 35	35	20	8	16	3	13	5.6
VP 40	40	20	8	16	3	13	9
VP 50	52	22	8	18	4.5	13	14
VP 60	60	22	8	18	4.5	13	16
VP 75	75	32	12	23	4.5	20	33

Barbed Fittings

Male - IM

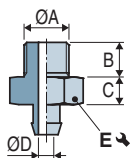

Female - IF

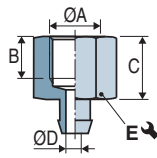

	ØA	B	C	ØD	E ↻	Material	⚖ (g)
IM 11 A	G1/8"-M	7.5	6	3.5	14	Aluminum	4.1
IMC 14	G1/4"-M	10	8	7	17	Aluminum	8.7
IM 21 (2)	M5-M	4.5	5	2.5	7	Nickel-plated brass	3.1
IM 22 (2)	M6-M	5	5	3.5	7	Nickel-plated brass	2.7
IM 23	10/32-M	4.5	5	2.5	7	Brass	3
IM 24	M5-M	4.5	2.5	2.5	10	Nickel-plated brass	3.2
IF 10 A	G1/8"-F	8	12	3.5	14	Aluminum	4
IFC 14	G1/4"-F	12	15	6.9	17	Aluminum	8

Hollow Screws

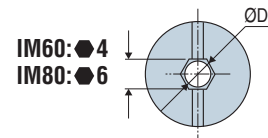
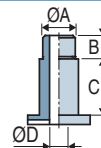

	ØA	B	C	ØD	Material	⚖ (g)
IM 50	M5-M	5	11	2.8	Brass	7.4
IM 60 (2) (3)	M6-M	7	11	3.5	Nickel-plated brass	7.5
IM 68	M8-M	8	11	5.2	Nickel-plated brass	6.4
IM 80	G1/8"-M	8	18	6	Nickel-plated brass	23.7
IM 85	M10x150-M	8	18	6	Nickel-plated brass	23.5

Factory-cripped Fittings

Male - IM

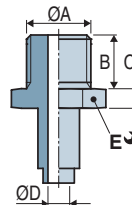

Female - IF

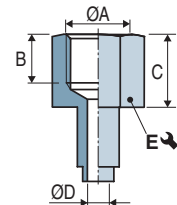

	ØA	B	C	ØD	E ↻	Material	⚖ (g)
IM 51	G1/4"-M	11	6	4.4	17	Aluminum	11.8
IF 50	G1/4"-F	10	15	8	21	Aluminum	15.7
IM 52	G3/8"-M	11	6	8	21	Aluminum	14

Adapters for Hollow Screws

Male - IM

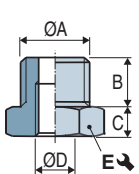

Female - IF

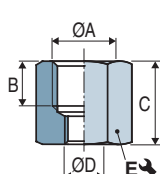

	ØA	B	C	ØD	E ↻	Material	⚖ (g)
IM 10 M6F	M10-M	7	3.5	M6-F	13	Brass	5.9
IM 12 F18	G1/2"-M	14	6	G1/8"-F	22	Nickel-plated brass	46.8
IM 14 M6F	G1/4"-M	8	5	M6-F	17	Nickel-plated brass	15.9
IM 14 F18	G1/4"-M	8	5	G1/8"-F	17	Nickel-plated brass	10.6
IM 18 M6F	G1/8"-M	6	4.5	M6-F	13	Nickel-plated brass	6.6
IM 38 F18	G3/8"-M	9	5	G1/8"-F	19	Nickel-plated brass	18.8
IF 14 M6F	G1/4"-F	11	16	M6-F	17	Nickel-plated brass	20.5
IF 18 M6F	G1/8"-F	7.5	13	M6-F	13	Nickel-plated brass	9.9
IF 14 F18	G1/4"-F	9	19	G1/8"-F	17	Nickel-plated brass	20.2

The values represent the average characteristics of our products.

Note: All dimensions are in mm.

(2) Flow restrictor version available: orifice calibrated to reduce leaks when used with a multi-cup gripper (see page 4/10).

(3) Available in stainless steel.

Pressed Fitting

Male - IM

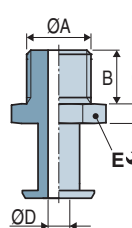

Female - IF

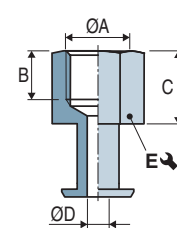

	ØA	B	C	ØD	E ↻	Material	⚖ (g)
IM 41	G1/4"-M	11	4	4.4	17	Aluminum	7.8
IF 40	G1/4"-F	10	15	4.4	17	Aluminum	8.4