

VPF

Flat Suction Cups with Cleats Ø 15 to 50 mm



VPF series suction cups are suitable for gripping flat, smooth and rigid products. Cleats prevent the deformation of the product and provide excellent non-slip properties.

Industry-specific applications

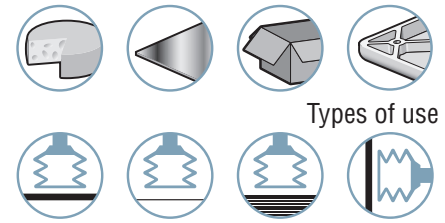

Types of use

Materials

NBR Nitrile **STN** SITON®
SI Translucent Silicone

2

VPF

Suction Cup Properties

	Ø (mm)	(cm ³)	(N) ⁽¹⁾	(N) ⁽¹⁾	(mm)	NBR	SI	STN
VPF 15	15.7	0.37	3.6	1.8	13	VPF15NBR	VPF15SI	VPF15STN(*)
VPF 20	22	1.00	7.2	3.6	18	VPF20NBR	VPF20SI	VPF20STN(*)
VPF 25	26.8	1.10	9.4	4.7	22	VPF25NBR	VPF25SI	VPF25STN(*)
VPF 30	32	2.00	11.6	5.8	25	VPF30NBR	VPF30SI	VPF30STN(*)
VPF 40	42.5	1.80	18.1	9.0	52	VPF40NBR	VPF40SI	VPF40STN(*)
VPF 50	53	10.00	34.7	17.3	55	VPF50NBR	VPF50SI	VPF50STN(*)

(1) Actual force of the suction cup in use with 65% vacuum and including a safety factor of 2 for horizontal handling and a factor of 4 for vertical handling.

(*) On request

Choice of Fittings

(Ø)	M5-M	G1/8"-M	G1/4"-M	G3/8"-M
15	■	-	-	-
20 - 30	-	■	-	-
40 - 50	-	-	■	■

■ Standard available configurations (suction cup + fitting) Fittings: M = Male
 Refer to n° table above

Type of Assembly

C **Version C: Barbed fitting**

E **Version E: Pressed fitting**

References "Suction Cup + Fitting"

Ø	THREAD	C		E					
		M5-M		G1/8"-M		G1/4"-M		G3/8"-M	
Ø 15 mm	VPF15NBR	VPF15NBRIMM5C		Fitting with filter	Fitting without filter				
	VPF15SI	VPF15SIIMM5C		VPF20NBR	VPF20NBRIM18MPF	VPF20NBRIM18MP			
	VPF15STN	VPF15STNIMM5C		VPF20SI	VPF20SIIM18MPF	VPF20SIIM18MP			
				VPF20STN(*)	VPF20STNIM18MPF	VPF20STNIM18MP			
				VPF25NBR	VPF25NBRIM18MPF	VPF25NBRIM18MP			
				VPF25SI	VPF25SIIM18MPF	VPF25SIIM18MP			
Ø 20 - 30 mm	VPF25STN(*)	VPF25STNIM18MPF		VPF25STNIM18MP					
	VPF30NBR	VPF30NBRIM18MPF		VPF30NBRIM18MP					
	VPF30SI	VPF30SIIM18MPF		VPF30SIIM18MP					
	VPF30STN(*)	VPF30STNIM18MPF		VPF30STNIM18MP					
Ø 40 - 50 mm	VPF40NBR	VPF40NBRIM14MPF		Fitting with filter	Fitting without filter	Fitting with filter	Fitting without filter		
	VPF40SI	VPF40SIIM14MPF		VPF40NBRIM14MP	VPF40NBRIM38MPF	VPF40NBRIM38MP			
	VPF40STN(*)	VPF40STNIM14MPF		VPF40SIIM14MP	VPF40SIIM38MPF	VPF40SIIM38MP			
	VPF50NBR	VPF50NBRIM14MPF		VPF40STNIM14MP	VPF40STNIM38MPF	VPF40STNIM38MP			
	VPF50SI	VPF50SIIM14MPF		VPF50NBRIM14MP	VPF50NBRIM38MPF	VPF50NBRIM38MP			
	VPF50STN(*)	VPF50STNIM14MPF		VPF50SIIM14MP	VPF50SIIM38MPF	VPF50SIIM38MP			

(*) On request

Accessories

To optimize use of your suction cups, Coval offers a comprehensive range of accessories (sensors, spring extensions, and feeder systems, etc.) see chapters 4 and 14.

Please specify the part n°. e.g. VPF20NBRIM18MPF
 See part n° table above

VPF

Flat Suction Cups with Cleats Ø 15 to 50 mm

Assembly Diagrams



Suction Cup + Fitting

VPF 15

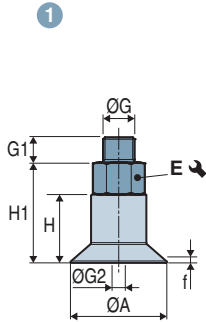

VPF 20...30

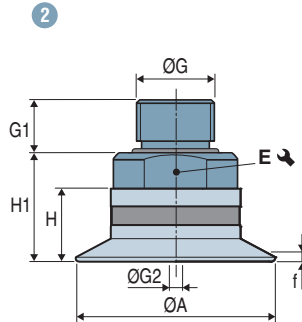

VPF 40...50

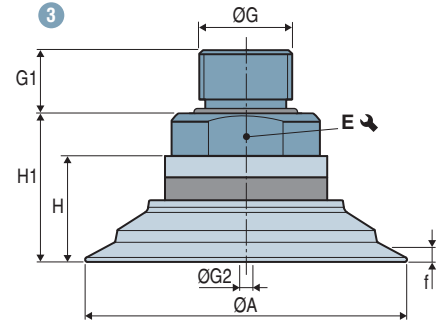

2
VPF

	Diagram	ØA	f ⁽¹⁾	H	H1	ØG	G1	ØG2 ⁽²⁾	E ↷	g (g)
VPF15---IMM5C	1	15.7	1	11	15.5	M5-M	4	2.7	7	1.5
VPF20---IM18MP-	2	22	1	8	13	G1/8"-M	7	4	13	4.4
VPF25---IM18MP-	2	26.8	1.3	9	14	G1/8"-M	7	4	13	4.9
VPF30---IM18MP-	2	32	1.8	10	15	G1/8"-M	7	4	13	5.4
VPF40---IM14MP-	3	42.5	1.9	13	19	G1/4"-M	9	5	19	12.6
VPF40---IM38MP-	3	42.5	1.9	13	19	G3/8"-M	10	5	22	17.2
VPF50---IM14MP-	3	53	2.4	17.5	23.5	G1/4"-M	9	6	22	24.8
VPF50---IM38MP-	3	53	2.4	17.5	23.5	G3/8"-M	10	6	23.9	27.8

(1) f = Deflection of the suction cup. (2) Ø G2 = Ø internal orifice of the fitting.

Assembly Diagrams

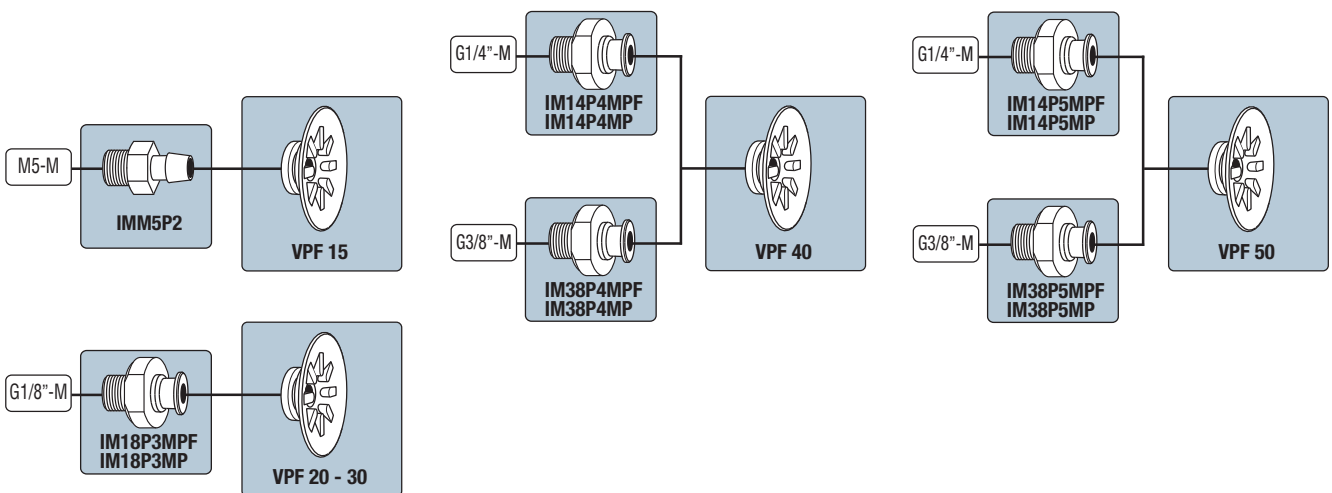

Note: All dimensions are in mm.

VPF

Flat Suction Cups with Cleats Ø 15 to 50 mm Assembly Diagrams



Suction Cups

VPF 15

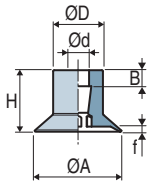

VPF 20...30

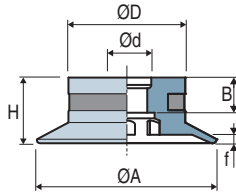

VPF 40...50

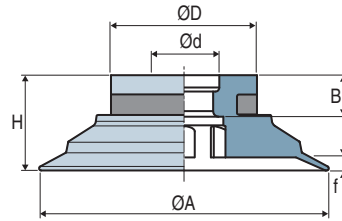

	Ø A	H	Ø d	Ø D	f (1)	B	(g)
 VPF 15	15.7	11	4	9	1	3	0.7
VPF 20	22	8	5	14.3	1	4.5	1.2
VPF 25	26.8	9	5	14.3	1.3	4.5	1.7
VPF 30	32	10	5	14.3	1.8	4.5	2.2
VPF 40	42.5	13	7	20	1.9	6	5.6
VPF 50	53	17.5	10.5	27	2.4	7.5	12.7

(1) f = Deflection of the suction cup.

Barbed Fittings

IMM5P2

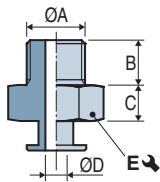

	Ø A	B	C	Ø D	E	Material	(g)
IMM5P2	M5-M	4	4.5	2.7	7	Aluminum	0.8

Pressed fittings

Male fittings

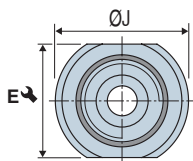
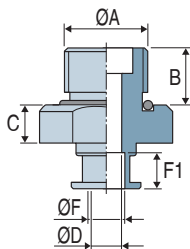

Fitting with stainless steel filter 200 µm	Fitting without filter	Ø A	B	C	Ø D	E	Ø J	Ø F	F1	Materials Fitting*	(g)
IM18P3MPF	IM18P3MP	G1/8"-M	7	5	4	13	15	5	4.7	Aluminum	3.2
IM14P4MPF	IM14P4MP	G1/4"-M	9	6	5	19	21	6	5.7	Aluminum	7
IM14P5MPF	IM14P5MP	G1/4"-M	9	6	6	22	28	10	8.7	Aluminum	12.1
IM38P4MPF	IM38P4MP	G3/8"-M	10	6	5	22	24	6	5.7	Aluminum	11.6
IM38P5MPF	IM38P5MP	G3/8"-M	10	6	6	23.9	28	10	8.7	Aluminum	15.1

*Male fittings (IM) equipped with O-ring sealing

Note: All dimensions are in mm.
The values represent the average characteristics of our products.