

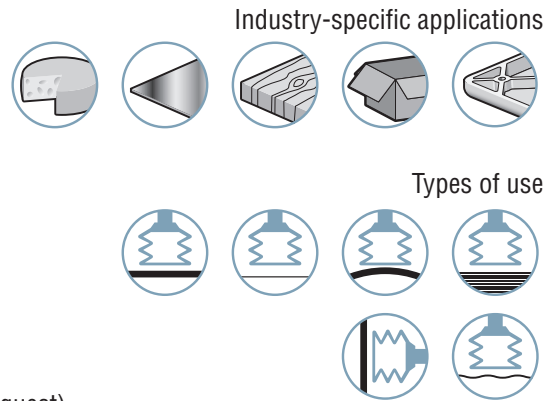

VSA series suction cups with bellows combine the advantages of flat suction cups with increased deflection, flexibility and precision. Used for gripping slightly concave or convex objects.

- Flexibility
- Precision
- Deflection

For delicate gripping requiring a very flexible lip (opening bags, gripping tins and flexible aluminum or plastic bottles, etc.), we recommend using 35 Shore A white silicone, SIB. For larger diameters, see page 3/7, MVS series.



VSA 2

Materials

NBR	Nitrile	SIT5	Translucent silicone
NR	Natural rubber	SIB	35 shore A white silicone
STN	SITON® 60 ShoreA	STN5	SITON® 50 ShoreA (on request)

Suction Cup Properties

	Ø (mm)	Volume (cm³)	Force (lbf) (1)	Force (lbf) (1)	R _{min} (mm)	NBR	SIT5	SIB	NR	STN (2)
VSA 5	5.5	0.04	0.11	0.06	10	VSA5NBR	VSA5SIT5	-	-	VSA5STN
VSA 11	11	0.225	0.39	0.19	10	VSA11NBR	VSA11SIT5	-	VSA11NR	VSA11STN
VSA 14	13	0.42	0.57	0.28	13	VSA14NBR	VSA14SIT5	-	VSA14NR	VSA14STN
VSA 16	16	0.75	0.60	0.30	20	VSA16NBR	VSA16SIT5	VSA16SIB	VSA16NR	VSA16STN
VSA 18	18	0.76	0.99	0.50	25	VSA18NBR	VSA18SIT5	VSA18SIB	VSA18NR	VSA18STN
VSA 20	19	1.15	1.25	0.63	30	VSA20NBR	VSA20SIT5	VSA20SIB	VSA20NR	VSA20STN
VSA 22	22	1.4	1.38	0.69	25	VSA22NBR	VSA22SIT5	VSA22SIB	VSA22NR	VSA22STN
VSA 25	24	3.15	1.79	0.89	20	VSA25NBR	VSA25SIT5	VSA25SIB	VSA25NR	VSA25STN
VSA 26	25	3.9	2.44	1.22	30	VSA26NBR	VSA26SIT5	-	VSA26NR	VSA26STN
VSA 33	33	4.75	3.12	1.56	40	VSA33NBR	VSA33SIT5	-	VSA33NR	VSA33STN
VSA 43	43	9.25	4.55	2.27	60	VSA43NBR	VSA43SIT5	-	VSA43NR	VSA43STN
VSA 53	53	26.25	9.58	4.79	75	VSA53NBR	VSA53SIT5	-	VSA53NR	VSA53STN
VSA 63	63	39.0	13.31	6.66	75	VSA63NBR	VSA63SIT5	-	VSA63NR	VSA63STN
VSA 78	78	76.0	24.68	12.34	70	VSA78NBR	VSA78SIT5	-	VSA78NR	VSA78STN

(1) Actual force of the suction cup in use with 65% vacuum and including a safety factor of 2 for horizontal handling and a factor of 4 for vertical handling.

(2) On request, some models are available in STN5 (SITON® 50 shore A)

Choice of Fittings

	Group	M3-M	M5-M	M6-M	M8-M	M10-M	G1/8"-F	G1/8"-M	10/32-M	G1/4"-F	G1/4"-M	G3/8"-M	G1/2"-M
5	1	■	-	-	-	-	-	-	-	-	-	-	-
11...25	1	-	■	■	-	-	■	■	□	-	-	-	-
26...63	2	-	□	□	□	□	■	■	-	■	■	-	-
78	3	-	-	-	-	□	-	■	-	■	■	■	□

■ Standard available configurations (suction cup + fitting): see page 2/28

□ Additional mounting configurations: see page 2/31 Fitting: M = male F = female

Types of Assembly

COVAL suction cups can be assembled in a wide variety of configurations.

C **Version C**
Barbed fitting

S **Version S**
Factory-crimped fitting

V **Version V**
Removable fitting:
(adapter and hollow screw)

E **Version E**
Pressed fitting

Textured Surfaces

For handling objects with a granular or textured gripping surface, use VSA suction cups with the VSBM foam strip option (see page 2/65).

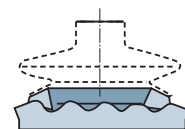

Please specify the part n°. e.g. VSA78NBRIM14C
Refer to page 2/28

Accessories

To optimize the use of your suction cups, Coval offers a comprehensive range of accessories (nozzle fittings, spring extensions, and feeder systems, etc.), see chapters 4 and 14.



Group 1		C				
THREAD	M3-M	M5-M	M6-M	G1/8"-M	G1/8"-F	
VSA5NBR	VSA5NBRIMM3C	-	-	-	-	
VSA5SIT5	VSA5SIT5IMM3C	-	-	-	-	
VSA5STN	VSA5STNIMM3C	-	-	-	-	
VSA11NBR	-	VSA11NBRIMM5C	VSA11NBRIMM6C	VSA11NBRIM18C	VSA11NBRIF18C	
VSA11NR	-	VSA11NRIMM5C	VSA11NRIMM6C	VSA11NRIM18C	VSA11NRIF18C	
VSA11SIT5	-	VSA11SIT5IMM5C	VSA11SIT5IMM6C	VSA11SIT5IM18C	VSA11SIT5IF18C	
VSA11STN	-	VSA11STNIMM5C	VSA11STNIMM6C	VSA11STNIM18C	VSA11STNIF18C	
VSA14NBR	-	VSA14NBRIMM5C	VSA14NBRIMM6C	VSA14NBRIM18C	VSA14NBRIF18C	
VSA14NR	-	VSA14NRIMM5C	VSA14NRIMM6C	VSA14NRIM18C	VSA14NRIF18C	
VSA14SIT5	-	VSA14SIT5IMM5C	VSA14SIT5IMM6C	VSA14SIT5IM18C	VSA14SIT5IF18C	
VSA14STN	-	VSA14STNIMM5C	VSA14STNIMM6C	VSA14STNIM18C	VSA14STNIF18C	
VSA16NBR	-	VSA16NBRIMM5C	VSA16NBRIMM6C	VSA16NBRIM18C	VSA16NBRIF18C	
VSA16NR	-	VSA16NRIMM5C	VSA16NRIMM6C	VSA16NRIM18C	VSA16NRIF18C	
VSA16SIB	-	VSA16SIBIMM5C	VSA16SIBIMM6C	VSA16SIBIM18C	VSA16SIBIF18C	
VSA16SIT5	-	VSA16SIT5IMM5C	VSA16SIT5IMM6C	VSA16SIT5IM18C	VSA16SIT5IF18C	
VSA16STN	-	VSA16STNIMM5C	VSA16STNIMM6C	VSA16STNIM18C	VSA16STNIF18C	
VSA18NBR	-	VSA18NBRIMM5C	VSA18NBRIMM6C	VSA18NBRIM18C	VSA18NBRIF18C	
VSA18NR	-	VSA18NRIMM5C	VSA18NRIMM6C	VSA18NRIM18C	VSA18NRIF18C	
VSA18SIB	-	VSA18SIBIMM5C	VSA18SIBIMM6C	VSA18SIBIM18C	VSA18SIBIF18C	
VSA18SIT5	-	VSA18SIT5IMM5C	VSA18SIT5IMM6C	VSA18SIT5IM18C	VSA18SIT5IF18C	
VSA18STN	-	VSA18STNIMM5C	VSA18STNIMM6C	VSA18STNIM18C	VSA18STNIF18C	
VSA20NBR	-	VSA20NBRIMM5C	VSA20NBRIMM6C	VSA20NBRIM18C	VSA20NBRIF18C	
VSA20NR	-	VSA20NRIMM5C	VSA20NRIMM6C	VSA20NRIM18C	VSA20NRIF18C	
VSA20SIB	-	VSA20SIBIMM5C	VSA20SIBIMM6C	VSA20SIBIM18C	VSA20SIBIF18C	
VSA20SIT5	-	VSA20SIT5IMM5C	VSA20SIT5IMM6C	VSA20SIT5IM18C	VSA20SIT5IF18C	
VSA20STN	-	VSA20STNIMM5C	VSA20STNIMM6C	VSA20STNIM18C	VSA20STNIF18C	
VSA22NBR	-	VSA22NBRIMM5C	VSA22NBRIMM6C	VSA22NBRIM18C	VSA22NBRIF18C	
VSA22NR	-	VSA22NRIMM5C	VSA22NRIMM6C	VSA22NRIM18C	VSA22NRIF18C	
VSA22SIB	-	VSA22SIBIMM5C	VSA22SIBIMM6C	VSA22SIBIM18C	VSA22SIBIF18C	
VSA22SIT5	-	VSA22SIT5IMM5C	VSA22SIT5IMM6C	VSA22SIT5IM18C	VSA22SIT5IF18C	
VSA22STN	-	VSA22STNIMM5C	VSA22STNIMM6C	VSA22STNIM18C	VSA22STNIF18C	
VSA25NBR	-	VSA25NBRIMM5C	VSA25NBRIMM6C	VSA25NBRIM18C	VSA25NBRIF18C	
VSA25NR	-	VSA25NRIMM5C	VSA25NRIMM6C	VSA25NRIM18C	VSA25NRIF18C	
VSA25SIB	-	VSA25SIBIMM5C	VSA25SIBIMM6C	VSA25SIBIM18C	VSA25SIBIF18C	
VSA25SIT5	-	VSA25SIT5IMM5C	VSA25SIT5IMM6C	VSA25SIT5IM18C	VSA25SIT5IF18C	
VSA25STN	-	VSA25STNIMM5C	VSA25STNIMM6C	VSA25STNIM18C	VSA25STNIF18C	

Additional mounting configurations are available (see page 2/31). For standard configurations (suction cup+fitting), the C and V versions are delivered unassembled.

Group 2		C		E		V		
THREAD	G1/4"-M	G1/4"-F	G1/4"-M	G1/4"-F	G1/8"-M	G1/8"-F	G1/4"-M	G1/4"-F
VSA26NBR	VSA26NBRIM14C	VSA26NBRIF14C	VSA26NBRIM14	VSA26NBRIF14	VSA26NBRIM18V	VSA26NBRIF18V	VSA26NBRIM14V	VSA26NBRIF14V
VSA26NR	VSA26NRIM14C	VSA26NRIF14C	VSA26NRIM14	VSA26NRIF14	VSA26NRIM18V	VSA26NRIF18V	VSA26NRIM14V	VSA26NRIF14V
VSA26SIT5	VSA26SIT5IM14C	VSA26SIT5IF14C	VSA26SIT5IM14	VSA26SIT5IF14	VSA26SIT5IM18V	VSA26SIT5IF18V	VSA26SIT5IM14V	VSA26SIT5IF14V
VSA26STN	VSA26STNIM14C	VSA26STNIF14C	VSA26STNIM14	VSA26STNIF14	VSA26STNIM18V	VSA26STNIF18V	VSA26STNIM14V	VSA26STNIF14V
VSA33NBR	VSA33NBRIM14C	VSA33NBRIF14C	VSA33NBRIM14	VSA33NBRIF14	VSA33NBRIM18V	VSA33NBRIF18V	VSA33NBRIM14V	VSA33NBRIF14V
VSA33NR	VSA33NRIM14C	VSA33NRIF14C	VSA33NRIM14	VSA33NRIF14	VSA33NRIM18V	VSA33NRIF18V	VSA33NRIM14V	VSA33NRIF14V
VSA33SIT5	VSA33SIT5IM14C	VSA33SIT5IF14C	VSA33SIT5IM14	VSA33SIT5IF14	VSA33SIT5IM18V	VSA33SIT5IF18V	VSA33SIT5IM14V	VSA33SIT5IF14V
VSA33STN	VSA33STNIM14C	VSA33STNIF14C	VSA33STNIM14	VSA33STNIF14	VSA33STNIM18V	VSA33STNIF18V	VSA33STNIM14V	VSA33STNIF14V
VSA43NBR	VSA43NBRIM14C	VSA43NBRIF14C	VSA43NBRIM14	VSA43NBRIF14	VSA43NBRIM18V	VSA43NBRIF18V	VSA43NBRIM14V	VSA43NBRIF14V
VSA43NR	VSA43NRIM14C	VSA43NRIF14C	VSA43NRIM14	VSA43NRIF14	VSA43NRIM18V	VSA43NRIF18V	VSA43NRIM14V	VSA43NRIF14V
VSA43SIT5	VSA43SIT5IM14C	VSA43SIT5IF14C	VSA43SIT5IM14	VSA43SIT5IF14	VSA43SIT5IM18V	VSA43SIT5IF18V	VSA43SIT5IM14V	VSA43SIT5IF14V
VSA43STN	VSA43STNIM14C	VSA43STNIF14C	VSA43STNIM14	VSA43STNIF14	VSA43STNIM18V	VSA43STNIF18V	VSA43STNIM14V	VSA43STNIF14V
VSA53NBR	VSA53NBRIM14C	VSA53NBRIF14C	VSA53NBRIM14	VSA53NBRIF14	VSA53NBRIM18V	VSA53NBRIF18V	VSA53NBRIM14V	VSA53NBRIF14V
VSA53NR	VSA53NRIM14C	VSA53NRIF14C	VSA53NRIM14	VSA53NRIF14	VSA53NRIM18V	VSA53NRIF18V	VSA53NRIM14V	VSA53NRIF14V
VSA53SIT5	VSA53SIT5IM14C	VSA53SIT5IF14C	VSA53SIT5IM14	VSA53SIT5IF14	VSA53SIT5IM18V	VSA53SIT5IF18V	VSA53SIT5IM14V	VSA53SIT5IF14V
VSA53STN	VSA53STNIM14C	VSA53STNIF14C	VSA53STNIM14	VSA53STNIF14	VSA53STNIM18V	VSA53STNIF18V	VSA53STNIM14V	VSA53STNIF14V
VSA63NBR	VSA63NBRIM14C	VSA63NBRIF14C	VSA63NBRIM14	VSA63NBRIF14	VSA63NBRIM18V	VSA63NBRIF18V	VSA63NBRIM14V	VSA63NBRIF14V
VSA63NR	VSA63NRIM14C	VSA63NRIF14C	VSA63NRIM14	VSA63NRIF14	VSA63NRIM18V	VSA63NRIF18V	VSA63NRIM14V	VSA63NRIF14V
VSA63SIT	VSA63SITIM14C	VSA63SITIF14C	VSA63SITIM14	VSA63SITIF14	VSA63SITIM18V	VSA63SITIF18V	VSA63SITIM14V	VSA63SITIF14V
VSA63STN	VSA63STNIM14C	VSA63STNIF14C	VSA63STNIM14	VSA63STNIF14	VSA63STNIM18V	VSA63STNIF18V	VSA63STNIM14V	VSA63STNIF14V

Group 3		V			S		
THREAD	G1/8"-M	G1/4"-M	G1/4"-F	G1/4"-M	G1/4"-F	G3/8"-M	
VSA78NBR	VSA78NBRIM18V	VSA78NBRIM14V	VSA78NBRIF14V	VSA78NBRIM14	VSA78NBRIF14	VSA78NBRIM38	
VSA78NR	VSA78NRIM18V	VSA78NRIM14V	VSA78NRIF14V	VSA78NRIM14	VSA78NRIF14	VSA78NRIM38	
VSA78SIT5	VSA78SIT5IM18V	VSA78SIT5IM14V	VSA78SIT5IF14V	VSA78SIT5IM14	VSA78SIT5IF14	VSA78SIT5IM38	
VSA78STN	VSA78STNIM18V	VSA78STNIM14V	VSA78STNIF14V	VSA78STNIM14	VSA78STNIF14	VSA78STNIM38	



VSA 5 Group 1 **VSA 11 - 25 Group 1**

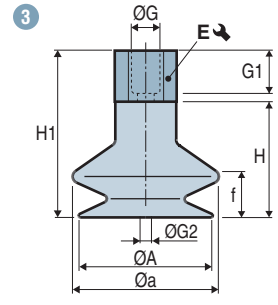
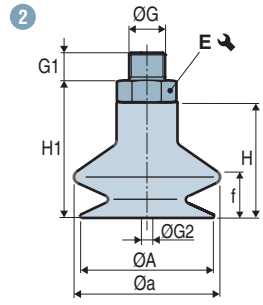
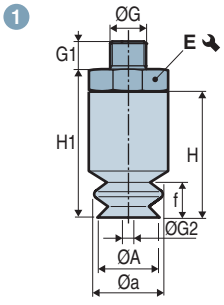

VSA 26 - 43 Group 2 **VSA 53 - 63 Group 2 / VSA 78 Group 3**

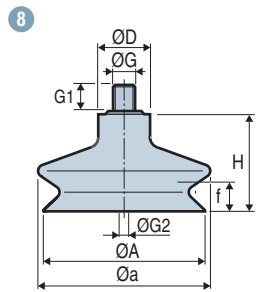
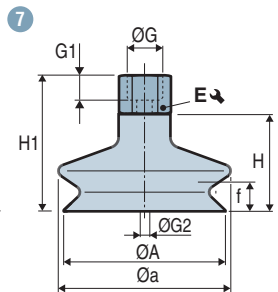
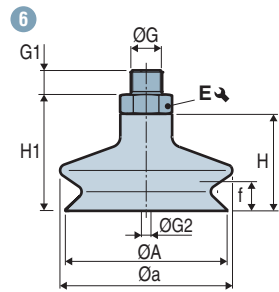
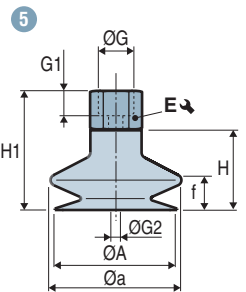
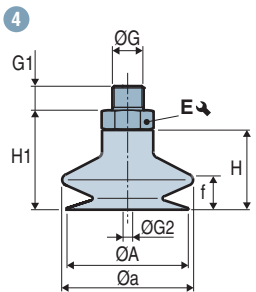

Group 1	Diagram	ØA	Øa	ØD	f ⁽¹⁾	H	H1	ØG	G1	ØG2 ⁽²⁾	E ↻	⊃ (g)
VSA5---IMM3C	1	5.5	6	-	2	11	13	M3-M	3	1.4	5	0.7
VSA11---IMM5C	2	11	12.2	-	5.5	16	21	M5-M	4.5	2.5	7	4
VSA11---IMM6C	2	11	12.2	-	5.5	16	21	M6-M	5	3.5	7	3.6
VSA11---IM18C	2	11	12.2	-	5.5	16	22	G1/8"-M	7.5	3.5	14	5
VSA11---IF18C	3	11	12.2	-	5.5	16	28	G1/8"-F	8	3.5	14	4.9
VSA14---IMM5C	2	13	14	-	5	16	21	M5-M	4.5	2.5	7	4.2
VSA14---IMM6C	2	13	14	-	5	16	21	M6-M	5	3.5	7	3.8
VSA14---IM18C	2	13	14	-	5	16	22	G1/8"-M	7.5	3.5	14	5.2
VSA14---IF18C	3	13	14	-	5	16	28	G1/8"-F	8	3.5	14	5.1
VSA16---IMM5C	2	16	17.3	-	8.5	19	24	M5-M	4.5	2.5	7	4.4
VSA16---IMM6C	2	16	17.3	-	8.5	19	24	M6-M	5	3.5	7	4
VSA16---IM18C	2	16	17.3	-	8.5	19	25	G1/8"-M	7.5	3.5	14	5.4
VSA16---IF18C	3	16	17.3	-	8.5	19	31	G1/8"-F	8	3.5	14	5.3
VSA18---IMM5C	2	18	18	-	5	16.5	21.5	M5-M	4.5	2.5	7	4.6
VSA18---IMM6C	2	18	18	-	5	16.5	21.5	M6-M	5	3.5	7	4.2
VSA18---IM18C	2	18	18	-	5	16.5	22.5	G1/8"-M	7.5	3.5	14	5.6
VSA18---IF18C	3	18	18	-	5	16.5	28.5	G1/8"-F	8	3.5	14	5.5
VSA20---IMM5C	2	19	20	-	5	16	21	M5-M	4.5	2.5	7	4.8
VSA20---IMM6C	2	19	20	-	5	16	21	M6-M	5	3.5	7	5.8
VSA20---IM18C	2	19	20	-	5	16	22	G1/8"-M	7.5	3.5	14	5.8
VSA20---IF18C	3	19	20	-	5	16	28	G1/8"-F	8	3.5	14	5.7
VSA22---IMM5C	2	22	24	-	8	19	24	M5-M	4.5	2.5	7	5.2
VSA22---IMM6C	2	22	24	-	8	19	24	M6-M	5	3.5	7	4.8
VSA22---IM18C	2	22	24	-	8	19	25	G1/8"-M	7.5	3.5	14	6.2
VSA22---IF18C	3	22	24	-	8	19	31	G1/8"-F	8	3.5	14	6.1
VSA25---IMM5C	2	24	25	-	12	23	28	M5-M	4.5	2.5	7	6
VSA25---IMM6C	2	24	25	-	12	23	28	M6-M	5	3.5	7	5.8
VSA25---IM18C	2	24	25	-	12	23	29	G1/8"-M	7.5	3.5	14	7
VSA25---IF18C	3	24	25	-	12	23	35	G1/8"-F	8	3.5	14	6.9

Note: All dimensions are in mm.

(1) f = Deflection of the suction cup. (2) Ø G2 = Ø internal orifice of the fitting.



Group 2	Diagram	ØA	Øa	ØD	f ⁽¹⁾	H	H1	ØG	G1	ØG2 ⁽²⁾	E ↻	⊞ (g)	
Ø 26 - 63 mm	VSA26---IM18V	4	25	30	-	6	25	29.5	G1/8"-M	6	3.5	13	18.7
	VSA26---IF18V	5	25	30	-	6	25	38	G1/8"-F	7.5	3.5	13	22
	VSA26---IM14	4	25	30	-	6	25	29	G1/4"-M	11	4.4	17	12.4
	VSA26---IM14C	4	25	30	-	6	25	33	G1/4"-M	10	7	17	13.3
	VSA26---IM14V	4	25	30	-	6	25	30	G1/4"-M	8	3.5	17	28
	VSA26---IF14	5	25	30	-	6	25	40	G1/4"-F	10	4.4	17	13
	VSA26---IF14C	5	25	30	-	6	25	40	G1/4"-F	12	6.9	17	12.6
	VSA26---IF14V	5	25	30	-	6	25	41	G1/4"-F	11	3.5	17	32.6
	VSA33---IM18V	4	33	36.2	-	11	27.5	32	G1/8"-M	6	3.5	13	21.1
	VSA33---IF18V	5	33	36.2	-	11	27.5	40.5	G1/8"-F	7.5	3.5	13	24.4
	VSA33---IM14	4	33	36.2	-	11	27.5	31.5	G1/4"-M	11	4.4	17	14.8
	VSA33---IM14C	4	33	36.2	-	11	27.5	35.5	G1/4"-M	10	7	17	15.7
	VSA33---IM14V	4	33	36.2	-	11	27.5	32.5	G1/4"-M	8	3.5	17	30.4
	VSA33---IF14	5	33	36.2	-	11	27.5	42.5	G1/4"-F	10	4.4	17	15.4
	VSA33---IF14C	5	33	36.2	-	11	27.5	42.5	G1/4"-F	12	6.9	17	15
	VSA33---IF14V	5	33	36.2	-	11	27.5	43.5	G1/4"-F	11	3.5	17	35
	VSA43---IM18V	4	43	46	-	12.5	28	32.5	G1/8"-M	6	3.5	13	25.9
	VSA43---IF18V	5	43	46	-	12.5	28	41	G1/8"-F	7.5	3.5	13	29.2
	VSA43---IM14	4	43	46	-	12.5	28	32	G1/4"-M	11	4.4	17	19.6
	VSA43---IM14C	4	43	46	-	12.5	28	36	G1/4"-M	10	7	17	20.5
	VSA43---IM14V	4	43	46	-	12.5	28	33	G1/4"-M	8	3.5	17	35.2
	VSA43---IF14	5	43	46	-	12.5	28	43	G1/4"-F	10	4.4	17	20.2
	VSA43---IF14C	5	43	46	-	12.5	28	43	G1/4"-F	12	6.9	17	19.8
	VSA43---IF14V	5	43	46	-	12.5	28	44	G1/4"-F	11	3.5	17	39.8
	VSA53---IM18V	6	53	59	-	15	34	38.5	G1/8"-M	6	3.5	13	35
	VSA53---IF18V	7	53	59	-	15	34	47	G1/8"-F	7.5	3.5	13	38.3
	VSA53---IM14	6	53	59	-	15	34	38	G1/4"-M	11	4.4	17	28.7
	VSA53---IM14C	6	53	59	-	15	34	42	G1/4"-M	10	7	17	29.6
	VSA53---IM14V	6	53	59	-	15	34	39	G1/4"-M	8	3.5	17	44.3
	VSA53---IF14	7	53	59	-	15	34	49	G1/4"-F	10	4.4	17	29.3
VSA53---IF14C	7	53	59	-	15	34	49	G1/4"-F	12	6.9	17	28.9	
VSA53---IF14V	7	53	59	-	15	34	50	G1/4"-F	11	3.5	17	48.9	
VSA63---IM18V	6	63	67	-	15	34	38.5	G1/8"-M	6	3.5	13	39.1	
VSA63---IF18V	7	63	67	-	15	34	47	G1/8"-F	7.5	3.5	13	42.4	
VSA63---IM14	6	63	67	-	15	34	38	G1/4"-M	11	4.4	17	32.8	
VSA63---IM14C	6	63	67	-	15	34	42	G1/4"-M	10	7	17	33.7	
VSA63---IM14V	6	63	67	-	15	34	39	G1/4"-M	8	3.5	17	48.4	
VSA63---IF14	7	63	67	-	15	34	49	G1/4"-F	10	4.4	17	33.4	
VSA63---IF14C	7	63	67	-	15	34	49	G1/4"-F	12	6.9	17	33	
VSA63---IF14V	7	63	67	-	15	34	50	G1/4"-F	11	3.5	17	53	

Group 3

Ø 78 mm	VSA78---IM18V	8	78	83	25	14	46.8	-	G1/8"-M	8	6	-	85.4
	VSA78---IM14	6	78	83	-	14	46.8	52.8	G1/4"-M	11	8	21	70.2
	VSA78---IM14V	6	78	83	-	14	46.8	51.8	G1/4"-M	8	6	17	92.7
	VSA78---IF14	7	78	83	-	14	46.8	61.8	G1/4"-F	10	8	21	74.1
	VSA78---IF14V	7	78	83	-	14	46.8	65.8	G1/4"-F	9	6	17	102.3
	VSA78---IM38	6	78	83	-	14	46.8	52.8	G3/8"-M	11	8	21	72.4

Note: All dimensions are in mm.

(1) f = Deflection of the suction cup. (2) Ø G2 = Ø internal orifice of the fitting.

VSA

Suction Cups with 1.5 Bellows Ø 5 to 78 mm

Assembly Diagrams



2
VSA

VSA 5 - 25 Group 1

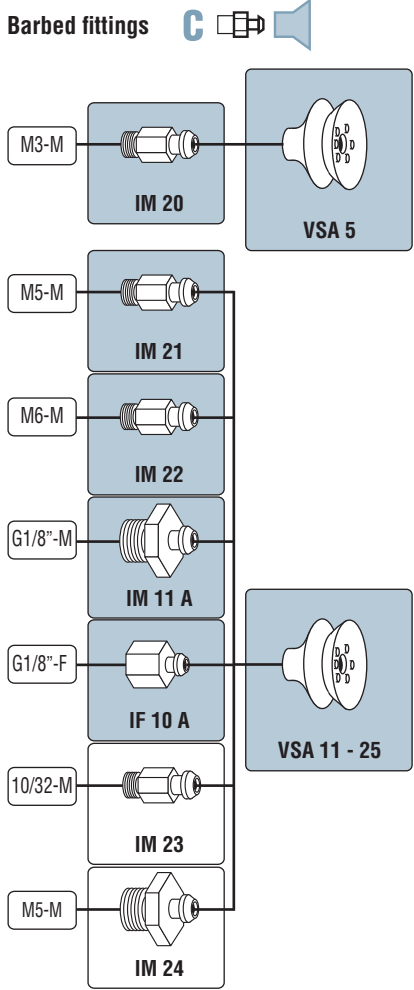

VSA 26 - 63 Group 2

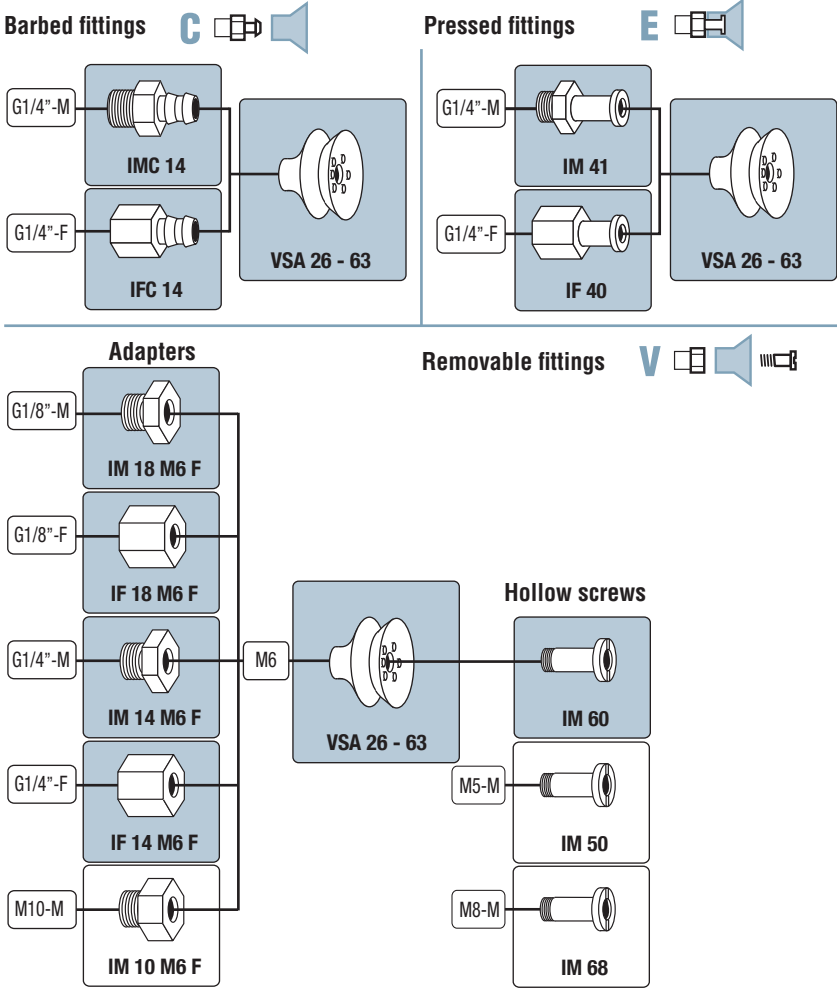

VSA 78 Group 3

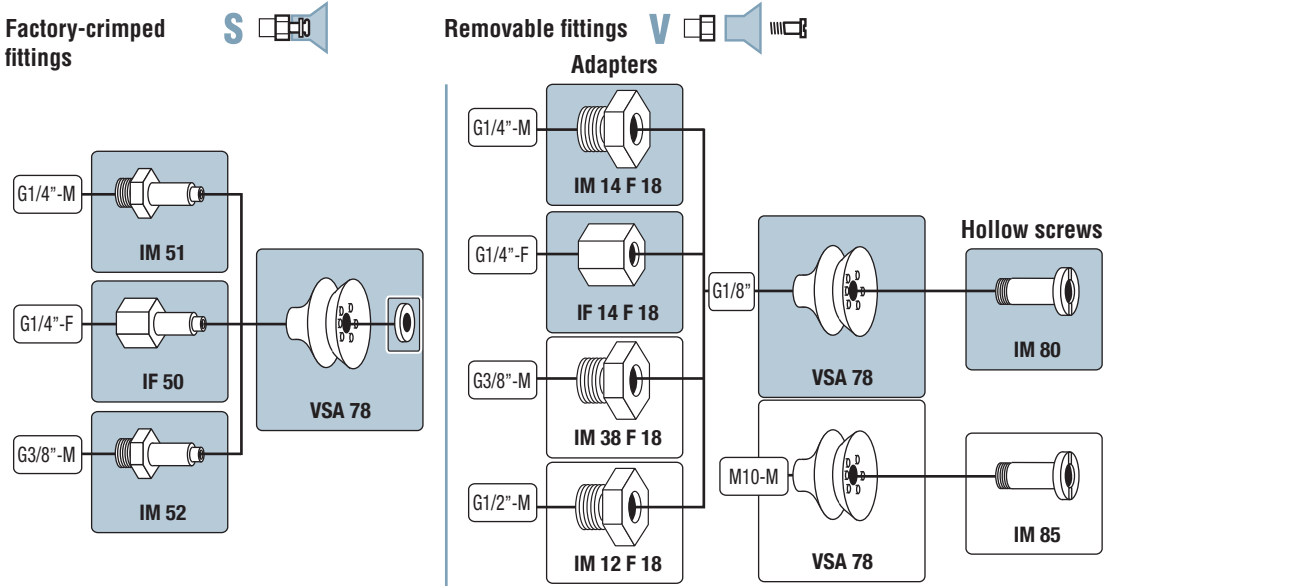

Configurations (suction cup + fitting) refer to pages 2/28
 Non-standard configurations must be ordered in separate part numbers.

Fittings and suction cups dimension:
see page 2/32.



Suction Cups

VSA 5

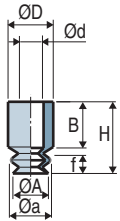

VSA 11 - 25

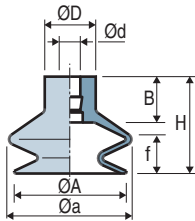

VSA 26 - 78

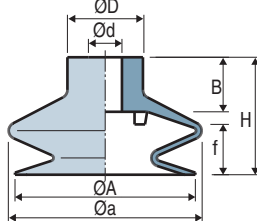

	Ø A	H	Ø a	Ø d	Ø D	f ⁽¹⁾	B	
VSA 5	5.5	11	6	4	7	2	7	0.3
VSA 11	11	16	12.2	4	10	5.5	9	0.9
VSA 14	13	16	14	4	10	5	9	1.1
VSA 16	16	19	17.3	4	10	8.5	9	1.3
VSA 18	18	16.5	18	4	10	5	9	1.5
VSA 20	19	16	20	4	10	5	9	1.7
VSA 22	22	19	24	4	10	8	9	2.1
VSA 25	24	23	25	4	10	12	9	2.9
VSA 26	25	25	30	8	16	6	13	4.6
VSA 33	33	27.5	36.2	8	18	11	13	7
VSA 43	43	28	46	8	18	12.5	13	11.8
VSA 53	53	34	59	8	18	15	13	20.9
VSA 63	63	34	67	8	18	15	13	25
VSA 78	78	46.8	83	12	25	14	20	58.4

Pressed Fittings

Male - IM

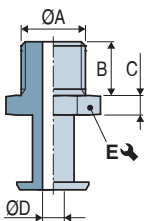

Female - IF

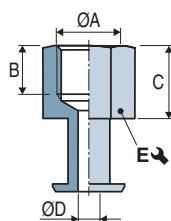

	ØA	B	C	ØD	E	Material	
IM41	G1/4"-M	11	4	4.4	17	Aluminum	7.8
IF40	G1/4"-F	10	15	4.4	17	Aluminum	8.4

Factory-Crimped Fittings

Male - IM

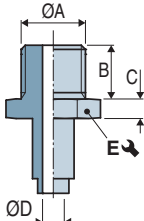

Female - IF

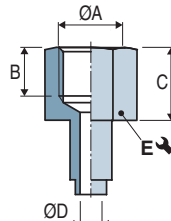

	ØA	B	C	ØD	E	Material	
IM 51	G1/4"-M	11	6	4.4	17	Aluminum	11.8
IF 50	G1/4"-F	10	15	8	21	Aluminum	15.7
IM 52	G3/8"-M	11	6	8	21	Aluminum	14

Hollow Screws

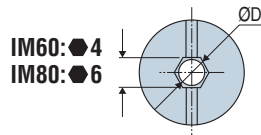
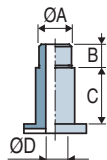

	ØA	B	C	ØD	Material	
IM 50	M5-M	5	11	2.8	Brass	7.4
IM 60 ^{(2) (3)}	M6-M	7	11	3.5	Nickel-plated brass	7.5
IM 68	M8-M	8	11	5.2	Nickel-plated brass	6.4
IM 80	G1/8"-M	8	18	6	Nickel-plated brass	23.7
IM 85	M10x150-M	8	18	6	Nickel-plated brass	23.5

The values represent the average characteristics of our products.

(2) Flow restrictor version available: orifice calibrated to reduce leaks when used with a multi-cup gripper (see page 4/10)

(3) Available in stainless steel

Barbed Fittings

Male - IM

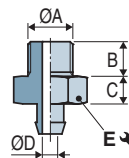

Female - IF

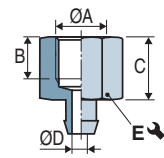

	ØA	B	C	ØD	E	Material	
IM 11 A	G1/8"-M	7.5	6	3.5	14	Aluminum	4.1
IMC 14	G1/4"-M	10	8	7	17	Aluminum	8.7
IM20	M3-M	3	2	1.4	5	Aluminum	0.4
IM 21 ⁽²⁾	M5-M	4.5	5	2.5	7	Nickel-plated brass	3.1
IM 22 ⁽²⁾	M6-M	5	5	3.5	7	Nickel-plated brass	2.7
IM 23	10/32-M	4.5	5	2.5	7	Brass	3
IM 24	M5-M	4.5	2.5	2.5	10	Nickel-plated brass	3.2
IF 10 A	G1/8"-F	8	12	3.5	14	Aluminum	4
IFC 14	G1/4"-F	12	15	6.9	17	Aluminum	8

Adapters for Hollow Screws

Male - IM

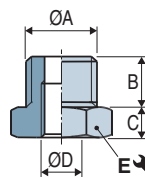

Female - IF

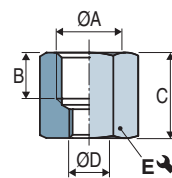

	ØA	B	C	ØD	E	Material	
IM 10 M6F	M10-M	7	3.5	M6-F	13	Brass	5.9
IM 12 F18	G1/2"-M	14	6	M6-F	22	Nickel-plated brass	46.5
IM 14 M6F	G1/4"-M	8	5	M6-F	17	Nickel-plated brass	15.9
IM 14 F18	G1/4"-M	8	5	G1/8"-F	17	Nickel-plated brass	10.6
IM 18 M6F	G1/8"-M	6	4.5	M6-F	13	Nickel-plated brass	6.6
IM 38 F18	G3/8"-M	9	5	G1/8"-F	19	Nickel-plated brass	18.8
IF 14 M6F	G1/4"-F	11	16	M6-F	17	Nickel-plated brass	20.5
IF 18 M6F	G1/8"-F	7.5	13	M6-F	13	Nickel-plated brass	9.9
IF 14 F18	G1/4"-F	9	19	G1/8"-F	17	Nickel-plated brass	20.2

Note: All dimensions are in mm.