

VSAG

Suction Cups with 1.5 Bellows Ø 10 to 150 mm

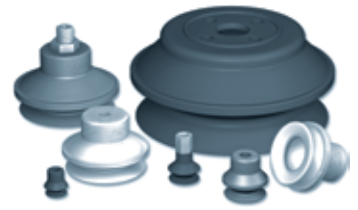

The VSAG series 1.5 bellows suction cups are recommended for gripping concave or convex products as well as sensitive products due to the cushioning effect of the bellows. The bellows also compensate for height variations in product gripping.

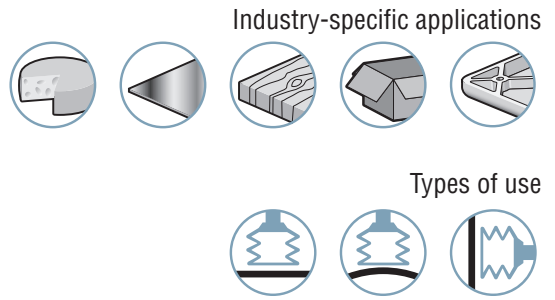

2 VSAG

Materials

- NBR** Nitrile
- SI** Translucent silicone
- STN** SITON®

Suction Cup Properties

	Ø (mm)	(cm³)	(lbf) ⁽¹⁾	(lbf) ⁽¹⁾	R _{min} (mm)	NBR	SI	STN
VSAG 10	10.7	0.2	0.41	0.21	4	VSAG10NBR	VSAG10SI	VSAG10STN
VSAG 15	15	0.7	0.57	0.29	6	VSAG15NBR	VSAG15SI	VSAG15STN
VSAG 20B	20	1	1.07	0.54	8	VSAG20BNBR	VSAG20BSI	VSAG20BSTN
VSAG 30	30	4	3.41	1.70	15	VSAG30NBR	VSAG30SI	-
VSAG 40	40	9	5.20	2.60	30	VSAG40NBR	VSAG40SI	-
VSAG 50	50	26	8.60	4.22	40	VSAG50NBR	VSAG50SI	-
VSAG 75	75	76	20.29	10.07	70	VSAG75NBR	VSAG75SI	VSAG75STN
VSAG 110	110	280	43.02	21.11	100	VSAG110NBR	VSAG110SI	VSAG110STN
VSAG 150	150	640	84.91	42.21	130	VSAG150NBR	VSAG150SI	-

(1) Actual force of the suction cup in use with a 65% vacuum and including a safety factor of 2 for horizontal handling and a factor of 4 for vertical handling.

Choice of Fittings

(Ø)	M5-F	M5-M	M6-M	M10-M	M10x125F	G1/8"-M	G1/8"-F	G1/4"-M	G1/4"-F	G1/2"-F
10...15	■	■	-	-	-	■	■	-	-	-
20...50	-	-	■	□	-	■	■	■	■	-
75	-	-	-	-	■	-	-	■	■	-
110...150	-	-	-	-	-	-	-	-	-	■

■ Standard available configurations (suction cup + fitting) refer to page 2/38

□ Additional mounting configurations see page 2/40

Fitting: M = male F = female

Types of Assembly

COVAL suction cups can be assembled in a wide variety of configurations:

C **Version C**
Barbed fitting

V **Version V**
Removable fitting (adapter and hollow screw)

Accessories

To optimize use of your suction cups, Coval offers a comprehensive range of accessories (sensors, spring extensions, and feeder systems, etc.) see chapters 4 and 14.

Please specify the part n°. e.g. VSAG10NBRIM18C
Refer to page 2/38

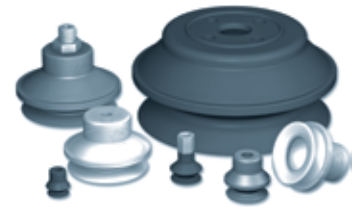

C

Ø 10 - 15 mm	THREAD	M5-M	M5-F	G1/8"-M	G1/8"-F
	VSAG10NBR	VSAG10NBRIMM5C	VSAG10NBRIFM5C	VSAG10NBRIM18C	VSAG10NBRIF18C
VSAG10SI	VSAG10SIIMM5C	VSAG10SIIFM5C	VSAG10SIIM18C	VSAG10SIIF18C	
VSAG10STN	VSAG10STNIMM5C	VSAG10STNIFM5C	VSAG10STNIM18C	VSAG10STNIF18C	
VSAG15NBR	VSAG15NBRIMM5C	VSAG15NBRIFM5C	VSAG15NBRIM18C	VSAG15NBRIF18C	
VSAG15SI	VSAG15SIIMM5C	VSAG15SIIFM5C	VSAG15SIIM18C	VSAG15SIIF18C	
VSAG15STN	VSAG15STNIMM5C	VSAG15STNIFM5C	VSAG15STNIM18C	VSAG15STNIF18C	

C | **V**

Ø 20 - 50 mm	THREAD	G1/8"-M	G1/8"-F	M6-M	G1/8"-M	G1/8"-F	G1/4"-M	G1/4"-F
	VSAG20BNBR	VSAG20BNBRIM18C	VSAG20BNBRIF18C	VSAG20BNBRIMM6V	VSAG20BNBRIM18V	VSAG20BNBRIF18V	VSAG20BNBRIM14V	VSAG20BNBRIF14V
VSAG20BSI	VSAG20BSIIM18C	VSAG20BSIIF18C	VSAG20BSIIMM6V	VSAG20BSIIM18V	VSAG20BSIIF18V	VSAG20BSIIM14V	VSAG20BSIIF14V	
VSAG20BSTN	VSAG20BSTNIM18C	VSAG20BSTNIF18C	VSAG20BSTNIMM6V	VSAG20BSTNIM18V	VSAG20BSTNIF18V	VSAG20BSTNIM14V	VSAG20BSTNIF14V	
VSAG30NBR	VSAG30NBRIM18C	VSAG30NBRIF18C	VSAG30NBRIMM6V	VSAG30NBRIM18V	VSAG30NBRIF18V	VSAG30NBRIM14V	VSAG30NBRIF14V	
VSAG30SI	VSAG30SIIM18C	VSAG30SIIF18C	VSAG30SIIMM6V	VSAG30SIIM18V	VSAG30SIIF18V	VSAG30SIIM14V	VSAG30SIIF14V	
VSAG40NBR	VSAG40NBRIM18C	VSAG40NBRIF18C	VSAG40NBRIMM6V	VSAG40NBRIM18V	VSAG40NBRIF18V	VSAG40NBRIM14V	VSAG40NBRIF14V	
VSAG40SI	VSAG40SIIM18C	VSAG40SIIF18C	VSAG40SIIMM6V	VSAG40SIIM18V	VSAG40SIIF18V	VSAG40SIIM14V	VSAG40SIIF14V	
VSAG50NBR	VSAG50NBRIM18C	VSAG50NBRIF18C	VSAG50NBRIMM6V	VSAG50NBRIM18V	VSAG50NBRIF18V	VSAG50NBRIM14V	VSAG50NBRIF14V	
VSAG50SI	VSAG50SIIM18C	VSAG50SIIF18C	VSAG50SIIMM6V	VSAG50SIIM18V	VSAG50SIIF18V	VSAG50SIIM14V	VSAG50SIIF14V	

V

Ø 75 mm	THREAD	M10x125 F	G1/4"-M	G1/4"-F
	VSAG75NBR	VSAG75NBR	VSAG75NBRIM14V	VSAG75NBRIF14V
VSAG75SI	VSAG75SI	VSAG75SIIM14V	VSAG75SIIF14V	
VSAG75STN	VSAG75STN	VSAG75STNIM14V	VSAG75STNIF14V	

V

Ø 110 - 150 mm	THREAD	G1/2"-F *	G1/2"-F **
	VSAG110NBR	VSAG110NBRIFS12V	VSAG110NBRIF12V
VSAG110SI	VSAG110SIIFS12V	VSAG110SIIF12V	
VSAG110STN	VSAG110STNIFS12V	VSAG110STNIF12V	
VSAG150NBR	VSAG150NBRIFS12V	VSAG150NBRIF12V	
VSAG150SI	VSAG150SIIFS12V	VSAG150SIIF12V	

*Configured using fitting n° IFS12120

** Configured using fitting n° IF12120

Additional mounting configurations are available (see page 2/40).
For standard configurations (suction cup+fitting), the C and V versions are delivered unassembled.



VSAG 10 - 15

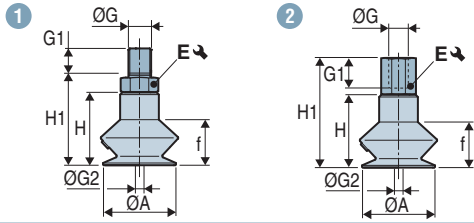

VSAG 20B - 50

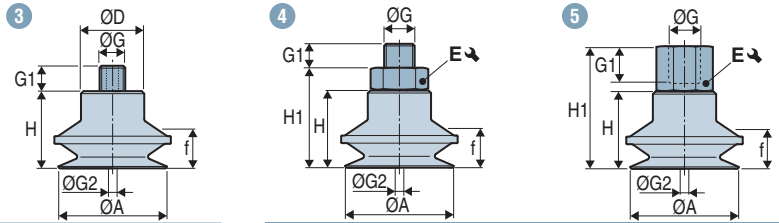

VSAG 75

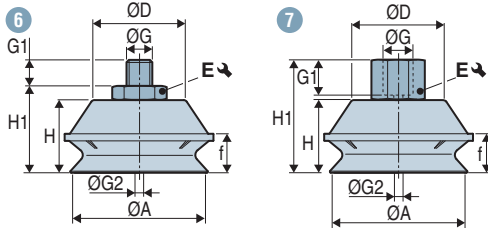

VSAG 110 - 150

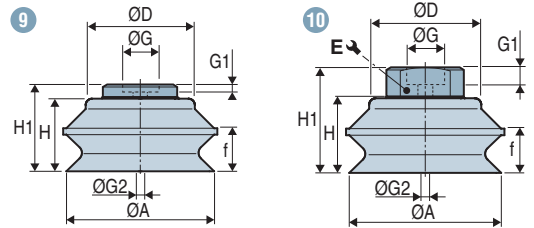

	Diagrams	ØA	ØD	f ⁽¹⁾	H	H1	ØG	G1	ØG2 ⁽²⁾	E ↘	⊖ (g)	
Ø 10 - 15 mm	VSAG10---IMM5C	1	10.7	-	5	13.3	16.8	M5-M	4.5	2.2	7	1.3
	VSAG10---IFM5C	2	10.7	-	5	13.3	22.3	M5-F	6	2.2	8	1.8
	VSAG10---IM18C	1	10.7	-	5	13.3	18.3	G1/8"-M	8	2.2	14	4.5
	VSAG10---IF18C	2	10.7	-	5	13.3	28.3	G1/8"-F	9	2.2	14	5.7
	VSAG15---IMM5C	1	15	-	10	16	19.5	M5-M	4.5	2.2	7	1.6
	VSAG15---IFM5C	2	15	-	10	16	25	M5-F	6	2.2	8	2.1
	VSAG15---IM18C	1	15	-	10	16	21	G1/8"-M	8	2.2	14	4.8
	VSAG15---IF18C	2	15	-	10	16	31	G1/8"-F	9	2.2	14	6
Ø 20B - 40 mm	VSAG20B---IM18C	4	20	-	12	22	27	G1/8"-M	8	4	14	7.1
	VSAG20B---IF18C	5	20	-	12	22	37	G1/8"-F	9	4	14	8.5
	VSAG20B---IMM6V	3	20	15	12	22	-	M6-M	6	3.5	-	5.7
	VSAG20B---IM18V	4	20	-	12	22	26.5	G1/8"-M	6	3.5	13	12.3
	VSAG20B---IF18V	5	20	-	12	22	35	G1/8"-F	7.5	3.5	13	15.6
	VSAG20B---IM14V	4	20	-	12	22	27	G1/4"-M	8	3.5	17	21.6
	VSAG20B---IF14V	5	20	-	12	22	38	G1/4"-F	11	3.5	17	26.2
	VSAG30---IM18C	4	30	-	17	30.5	35.5	G1/8"-M	8	4	14	13.2
	VSAG30---IF18C	5	30	-	17	30.5	45.5	G1/8"-F	9	4	14	14.6
	VSAG30---IMM6V	3	30	20	17	30.5	-	M6-M	6	3.5	-	11.8
	VSAG30---IM18V	4	30	-	17	30.5	35	G1/8"-M	6	3.5	13	18.4
	VSAG30---IF18V	5	30	-	17	30.5	43.5	G1/8"-F	7.5	3.5	13	21.7
	VSAG30---IM14V	4	30	-	17	30.5	35.5	G1/4"-M	8	3.5	17	27.7
	VSAG30---IF14V	5	30	-	17	30.5	46.5	G1/4"-F	11	3.5	17	32.3
	VSAG40---IM18C	4	40	-	15.5	30.5	35.5	G1/8"-M	8	4	14	18.8
	VSAG40---IF18C	5	40	-	15.5	30.5	45.5	G1/8"-F	9	4	14	20.2
VSAG40---IMM6V	3	40	25	15.5	30.5	-	M6-M	6	3.5	-	17.4	
VSAG40---IM18V	4	40	-	15.5	30.5	35	G1/8"-M	6	3.5	13	24	
VSAG40---IF18V	5	40	-	15.5	30.5	43.5	G1/8"-F	7.5	3.5	13	27.3	
VSAG40---IM14V	4	40	-	15.5	30.5	35.5	G1/4"-M	8	3.5	17	33.3	
VSAG40---IF14V	5	40	-	15.5	30.5	46.5	G1/4"-F	11	3.5	17	37.9	
Ø 50 mm	VSAG50---IM18C	4	50	-	20	36.5	41.5	G1/8"-M	8	4	14	27.4
	VSAG50---IF18C	5	50	-	20	36.5	51.5	G1/8"-F	9	4	14	28.8
	VSAG50---IMM6V	3	50	-	20	36.5	-	M6-M	6	3.5	-	30
	VSAG50---IM18V	4	50	-	20	36.5	41	G1/8"-M	6	3.5	13	36.6
	VSAG50---IF18V	5	50	-	20	36.5	49.5	G1/8"-F	7.5	3.5	13	40
	VSAG50---IM14V	4	50	-	20	36.5	41.5	G1/4"-M	8	3.5	17	45.9
	VSAG50---IM14F	5	50	-	20	36.5	52.5	G1/4"-F	11	3.5	17	50.4
Ø 75 - 150 mm	VSAG75---	8	75	50.5	22	43.2	-	M10x125-F	-	-	-	87.6
	VSAG75---IM14V	6	75	50.5	22	43.2	48.2	G1/4"-M	10	5	17	94.6
	VSAG75---IF14V	7	75	50.5	22	43.2	60.2	G1/4"-F	10	5	17	95.9
	VSAG110---IF12V	10	110	85	32.5	55	85	G1/2"-F	24	19	48	488.8
	VSAG110---IFS12V	9	110	85	32.5	55	68	G1/2"-F	13	-	-	407.5
	VSAG150---IF12V	10	150	120	39.5	75.5	105.5	G1/2"-F	24	19	48	911.4
VSAG150---IFS12V	9	150	120	39.5	75.5	88.5	G1/2"-F	13	-	-	830.1	

Note: All dimensions are in mm.

(1) f = Deflection of the suction cup. (2) Ø G2 = Ø internal orifice of the fitting.

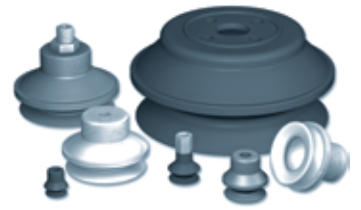

VSAG 10 - 15

Barbed fittings

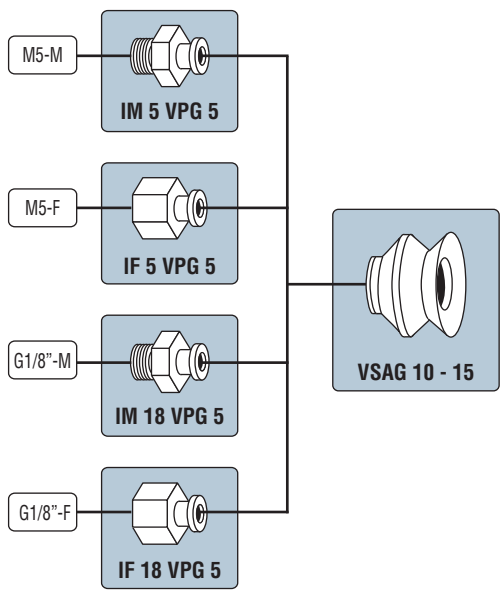

VSAG 20B - 50

Barbed fittings

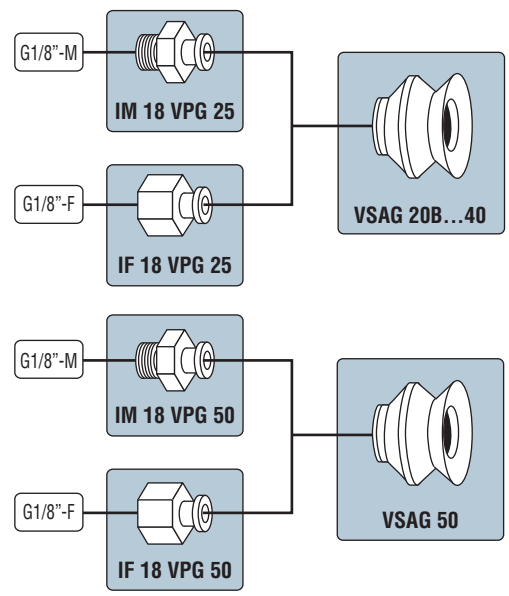

VSAG 20B - 50

Removable fittings

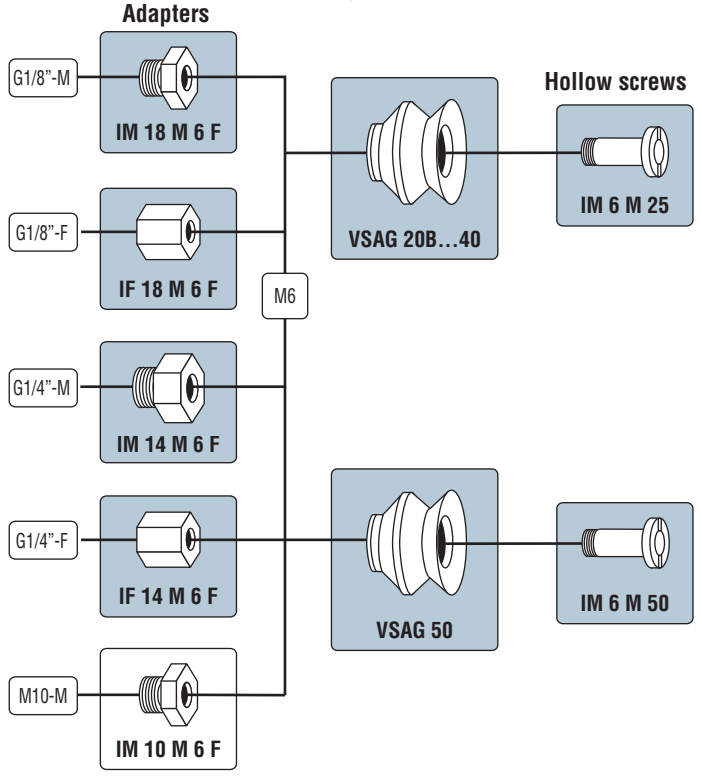

VSAG 75 - 150

Removable fittings

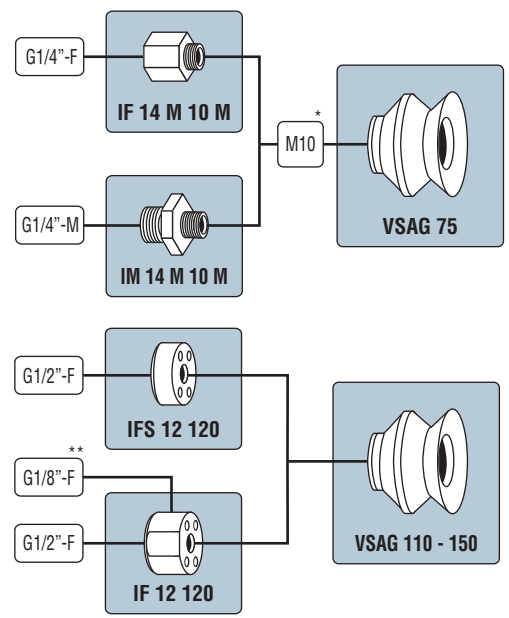

* 125 thread
** Female auxiliary radial output

- Configurations (suction cup + fitting) refer to page 2/38
- Non-standard configurations must be ordered in separate part numbers.

Fittings and suction cups dimensions: see pages 2/41 and 2/42.



VSAG 10 - 15

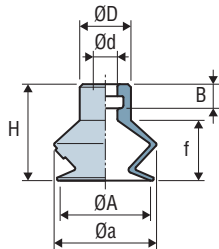

VSAG 20 - 50

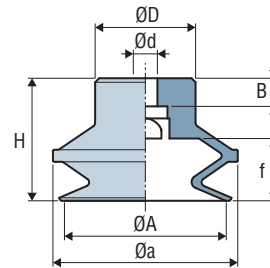

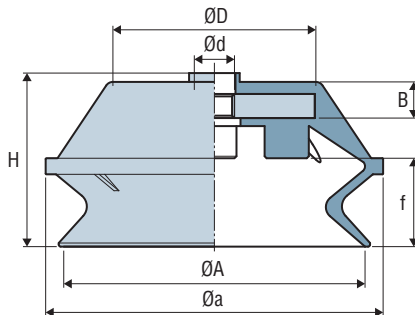

VSAG 75

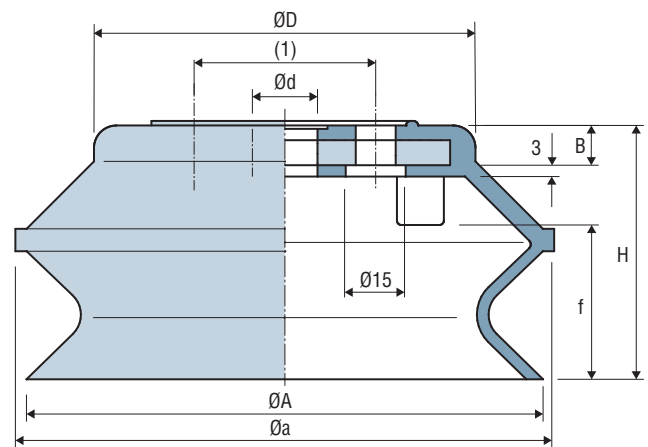

VSAG 110 - 150



(1) 4 holes \varnothing 9 on \varnothing 40

 (Ø)	ØA	H	Øa	Ød	ØD	f ⁽¹⁾	B	 (g)
VSAG 10	10.7	13.3	12.5	4	8.5	5	4	0.6
VSAG 15	15	16	17	4	8.5	10	4	0.9
VSAG 20 B	20	22	24	6	15	12	7	3
VSAG 30	30	30.5	36	6	20	17	7	9.1
VSAG 40	40	30.5	46	6	25	15.5	7	14.7
VSAG 50	50	36.5	59.5	7.8	28.5	20	7	22.5
VSAG 75	75	43.2	84	M10 x 125 - F	50.5	22	9	87.6
VSAG 110	110	55	121.5	14	85	32.5	9	264
VSAG 150	150	75.5	166	13	120	39.5	11	686.6

The values represent the average characteristics of our products.
Note: All dimensions are in mm.

(1) f = Deflection of the suction cup.

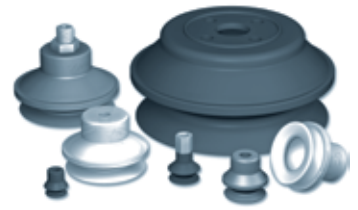

Barbed fittings

Male - IM

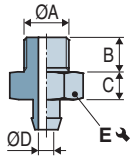

Female - IF

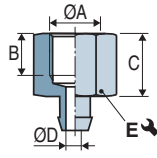

	ØA	B	C	ØD	E ↘	Material	⚖️ (g)
IM 5 VPG5	M5-M	4.5	3.5	2.2	7	Aluminum	0.7
IM 18 VPG5	G1/8"-M	8	5	2.2	14	Aluminum	3.9
IM 18 VPG25	G1/8"-M	8	5	4	14	Aluminum	4.1
IM 18 VPG50	G1/8"-M	8	5	4	14	Aluminum	4.9
IF 5 VPG5	M5-F	6	9	2.2	8	Aluminum	1.2
IF 18 VPG5	G1/8"-F	9	15	2.2	14	Aluminum	5.1
IF 18 VPG25	G1/8"-F	9	15	4	14	Aluminum	5.5
IF 18 VPG50	G1/8"-F	9	15	4	14	Aluminum	6.3

Hollow Screws

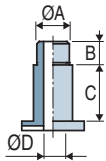

	ØA	B	C	ØD	Material	⚖️ (g)
IM 6 M25	M6-M	6	6	3.5	Nickel-plated brass	2.7
IM 6 M50	M6-M	6	6	3.5	Nickel-plated brass	7.5

Adapters for Hollow Screws

Male - IM

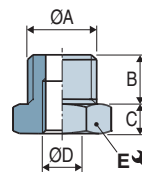

Female - IF

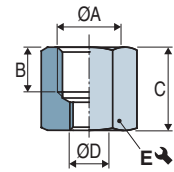

	ØA	B	C	ØD	E ↘	Material	⚖️ (g)
IM 10 M6F	M10-M	7	3.5	M6	13	Brass	5.9
IM 14 M6F	G1/4"-M	8	5	M6-F	17	Nickel-plated brass	15.9
IM 18 M6F	G1/8"-M	6	4.5	M6-F	13	Nickel-plated brass	6.6
IF 14 M6F	G1/4"-F	11	16	M6-F	17	Nickel-plated brass	20.5
IF 18 M6F	G1/8"-F	7.5	13	M6-F	13	Nickel-plated brass	9.9

Removable Fittings

Male - IM

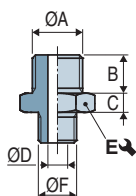

Female - IF

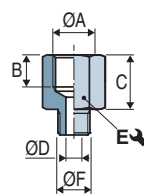

Female - IF 12120

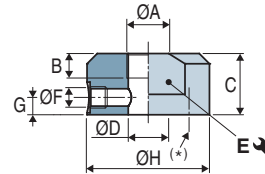

Female - IFS 12120

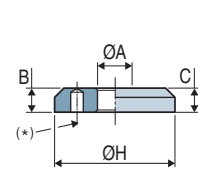

(1) 4 holes Ø 9 on Ø 40

	ØA	B	C	ØD	E ↘	ØF	G	H	Material	⚖️ (g)
IM 14 M10M	G1/4"-M	10	5	5	17	M10x125-M	-	-	Aluminum	7
IF 14 M10M	G1/4"-F	10	17	5	17	M10x125-M	-	-	Aluminum	8.3
IF 12120	G1/2"-F	24	30	19	48	G1/8"-F	8.7	60	Aluminum	224.8
IFS 12120	G1/2"-F	13	13	-	-	-	-	65	Aluminum	143.5

The values represent the average characteristics of our products.
Note: All dimensions are in mm.