

VSBO, VSBO+, VSBO LM/BM

Bottle Suction Cups - Product Selection Guide

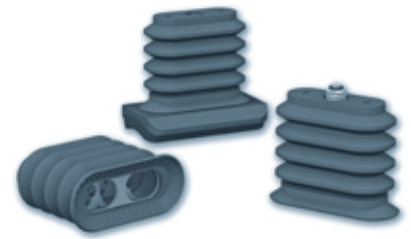

40 x 95 mm Bottle Suction Cups

p. 3/19

	VSBO 4095 C	NBR	D5	X	30
	TYPE	MATERIAL	REINFORCEMENTS	MOUNTING DISTANCE	
	Version VSBO -	NBR Nitrile	D5 <ul style="list-style-type: none"> 1 upper insert: stainless steel 4 reinforcements: stainless steel wire 1 lower reinforcement: stainless steel 	30 30 mm	
	Version VSBO+ C	NR Natural rubber	D6 <ul style="list-style-type: none"> 1 upper insert: stainless steel 4 reinforcements: stainless steel plates 1 lower reinforcement: stainless steel 	45 45 mm	
			D5P <ul style="list-style-type: none"> 1 upper insert: stainless steel 4 reinforcements: stainless steel wire 1 lower reinforcement: polypropylene 	-	
			D6P <ul style="list-style-type: none"> 1 upper insert: stainless steel 4 reinforcements: stainless steel plates 1 lower reinforcement: polypropylene 	30 and 45 mm (only available for VSBO+, cutout to be made on suction cup)	

Note: 40 mm mounting hole distance available upon request

40 x 95 mm Bottle Suction Cups with Sensing Valve

p. 3/21

	VSBO 4095 C	NBR	D5	CH4	30
	TYPE	MATERIAL	REINFORCEMENTS	VALVE TECHNOLOGY	MOUNTING DISTANCE
	Version VSBO -	NBR Nitrile	D5P <ul style="list-style-type: none"> 1 upper insert stainless steel wire 3 reinforcements: stainless steel wire 1 lower reinforcement: polypropylene 	CH2 V2 mechanical sensing valve (only with D6P reinforcements)	30 30 mm
	Version VSBO+ C			NR Natural rubber	D6P <ul style="list-style-type: none"> 1 upper insert stainless steel plates 3 reinforcements: stainless steel plates 1 lower reinforcement: polypropylene

Note: Version CHV_, including valve with calibrated leakage, available upon request.

Note: 40 mm mounting hole distance available upon request

Bottle Suction Cups with Gripping Interface

p. 3/24

	VSBO 50105	NBR	D5	X	45	BM10N
	REINFORCEMENTS		INTERFACE			
	<ul style="list-style-type: none"> 1 upper insert: stainless steel 4 reinforcements: stainless steel wire 1 lower reinforcement: stainless steel 	D5	BM10N POM support with 10 mm thick EPDM foam strip			
	<ul style="list-style-type: none"> 1 upper insert: stainless steel 4 reinforcements: stainless steel plates 1 lower reinforcement: stainless steel 		D6	LMNBR Nitrile Magnum lip 50 x 105 mm		

3 VSBO, VSBO+, VSBO LM/BM

VSBO, VSBO+

40 x 95 mm Bottle Suction Cups



Industry-specific applications



Types of use



COVAL has designed a complete range of 4.5 bellows suction cups, including internal reinforcements and a 40 x 95 mm gripping lip, to meet application requirements for handling 75 ml bottles from the side during vertical or horizontal gripping. To increase the lifting force while maintaining a long travel distance and great flexibility, **VSBO** and **VSBO+** suction cups include a stainless steel upper insert, four stainless steel reinforcements inside the bellows, and a lower reinforcement, available either in stainless steel or polypropylene.

VSBO+ suction cups feature anti-slip cleats on the lip to ensure that 75 ml bottles can be handled at high rates and in humid environments.

■ **Dual mounting option:** To provide users with more options, the bottle suction cups feature M6 threads, so that they can be mounted from the inside using with two M5 screws or from the top using two M6 screws.

Note: To handle magnum bottles or textured bottles, COVAL has designed a range of suction cups with various gripping interfaces (see VSBO LM/BM).

Materials

Suction cups

NBR Nitrile

NR Natural rubber

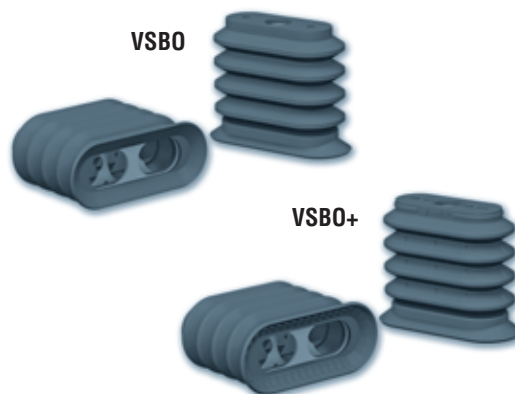

Suction Cup Characteristics

	Volume (cm ³)	Force (lbf) (1)	Force (lbf) (1)	f (2) (mm)	Weight (g)
VSBO 4095 (VSBO)	112.5	35.5	18.6	34	120
VSBO 4095C (VSBO+)	112.5	35.5	18.6	35.5	120

(1) Force measured at 65% on dry and smooth bottles without safety factor.

(2) f = Suction cup deflection.

Insert and Reinforcements

Version D5

- (a) 1 upper insert: stainless steel
- (b) 4 reinforcements: stainless steel wire
- (c) 1 lower reinforcement: stainless steel

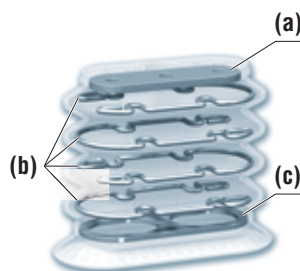

Version D5P

- (a) 1 upper insert: stainless steel
- (b) 4 reinforcements: stainless steel wire
- (c) 1 lower reinforcement: polypropylene

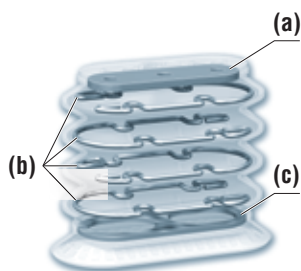

Version D6

- (a) 1 upper insert: stainless steel
- (b) 4 reinforcements: stainless steel plate
- (c) 1 lower reinforcement: stainless steel

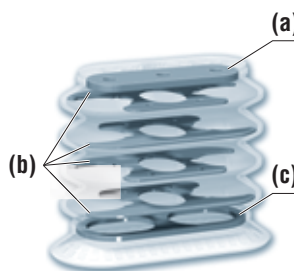

Version D6P

- (a) 1 upper insert: stainless steel
- (b) 4 reinforcements: stainless steel plate
- (c) 1 lower reinforcement: polypropylene

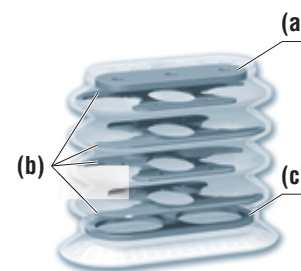

Mounting Hole Distance

VSBO and VSBO+ suction cups offer a choice of two mounting hole distances: 30 or 45 mm.

VSBO+ suction cups come in a version where the mounting holes have not been perforated, allowing users to choose during installation either a 30 mm or a 45 mm distance between mounting holes.

VSBO+ suction cups include integrated seals for easier mounting.

Available upon request: Vacuum switch connector

The VSBO and VSBO+ suction cups have a Ø 5 mm connector for a vacuum switch or blow-off valve. This option is only available for suction cups with a distance of 45 mm between mounting holes.

Integrated seals on VSBO+ suction cups

30 or 45 mm mounting distance

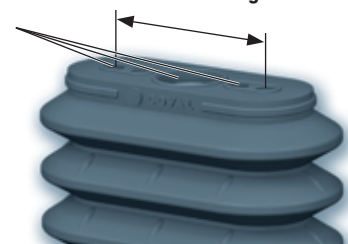

3 VSBO, VSBO+

VSBO, VSBO+

40 x 95 mm Bottle Suction Cups

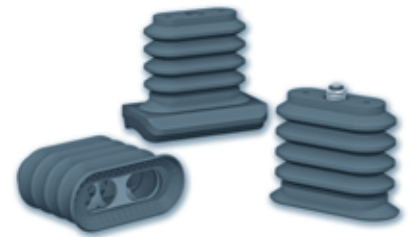

How To Order



VSBO 4095 C NBR D5 X 30

TYPE	MATERIAL	REINFORCEMENTS	MOUNTING DISTANCE
Version VSBO -	NBR Nitrile	<ul style="list-style-type: none"> 1 upper insert: stainless steel 4 reinforcements: stainless steel wire 	30 30 mm
Version VSBO+ C	NR Natural rubber	<ul style="list-style-type: none"> 1 lower reinforcement: stainless steel 	45 45 mm
		<ul style="list-style-type: none"> 1 upper insert: stainless steel 4 reinforcements: stainless steel plates 	- 30 and 45 mm (only available for VSBO+, cutout to be made on suction cup)
		<ul style="list-style-type: none"> 1 lower reinforcement: stainless steel 	
		<ul style="list-style-type: none"> 1 upper insert: stainless steel 4 reinforcements: stainless steel wire 	
		<ul style="list-style-type: none"> 1 lower reinforcement: polypropylene 	
		<ul style="list-style-type: none"> 1 upper insert: stainless steel 4 reinforcements: stainless steel plates 	
		<ul style="list-style-type: none"> 1 lower reinforcement: polypropylene 	

Note: 40 mm mounting hole distance available upon request

Suction Cup Dimensions

VSBO (VSBO4095)

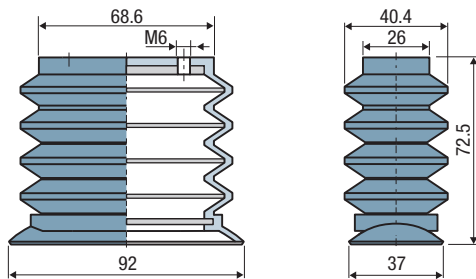

VSBO+ (VSBO4095C)

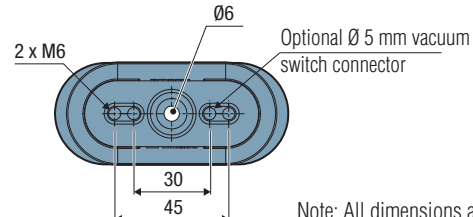
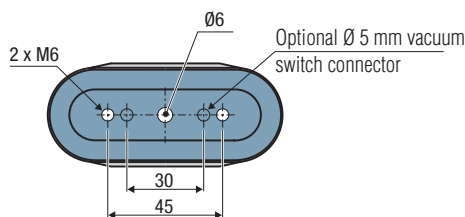
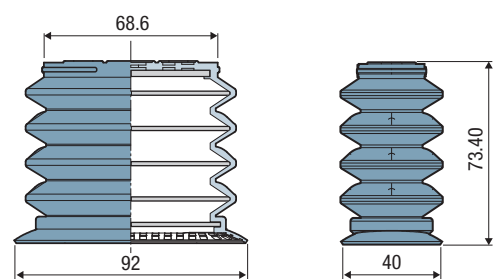

Note: All dimensions are in mm.

Replacement suction cups without insert or reinforcement



VSBO R 4095 C NBR N6 X 30

TYPE	MATERIAL	MOUNTING DISTANCE
Version VSBO -	NBR Nitrile	30 30 mm
Version VSBO+ C	NR Natural rubber	45 45 mm
		- 30 and 45 mm (only available for VSBO+, cutout to be made on suction cup)

VSBO, VSBO+

40 x 95 mm Bottle Suction Cups with Sensing Valve

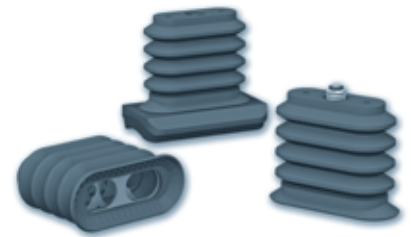

Industry-specific applications



Types of use



VSBO_CH2_



VSBO_CH4_

COVAL has designed a complete range of 4.5 bellows suction cups, featuring a sensing valve, internal reinforcements, a 40 x 95 mm gripping lip to handle 750 ml bottles, as well as the ability to limit vacuum leakage from the network should a bottle be missing.

VSBO and **VSBO+** suction cups are made for handling bottles from the side during vertical or horizontal gripping.

VSBO+ suction cups feature anti-slip cleats on the lip to ensure that 750 ml bottles can be handled at high rates and in humid environments.

VSBO and VSBO+ suction cup technology features two different mechanical sensing valves that isolate the suction cups should a bottle be missing.





To increase the lifting force while maintaining a long travel distance and great flexibility for packing/unpacking applications, VSBO and VSBO+ suction cups feature an upper insert, three reinforcements inside the bellows, and a lower reinforcement or a trigger plate.

Materials

Suction cups

- NBR** Nitrile
- NR** Natural rubber

Suction Cup Characteristics

	 (cm ³)	 (lbf) ⁽¹⁾	 (lbf) ⁽¹⁾	f ⁽²⁾ (mm)	 (g)
VSBO / VSBO+_CH2	112.5	35.5	18.6	34	125
VSBO / VSBO+_CH4	112.5	35.5	18.6	22	125

(1) Force measured at 65% on dry and smooth bottles without safety factor.

(2) f = Suction cup deflection.

Sensing Valve Technologies

CH2 mechanical sensing valve

The **CH2 sensing valve** opens as pressure is exerted on the suction cup by an **internal** reinforcement, called a “**trigger plate**”.

The CH2 sensing valve is only compatible with stainless steel reinforcement plates (version D6P).

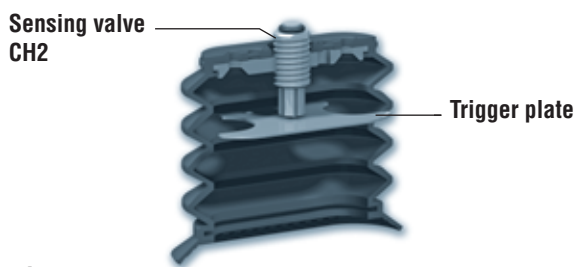

Advantages:

- Suction cup travel is not lost when suction cup is evacuated
- Adjustable valve
- Robust mechanical design

Materials:

- Upper insert: aluminum
- Valve body: aluminum
- O-ring: nitrile
- Spring: stainless steel
- Trigger plate: stainless steel

CH4 mechanical sensing valve

The **CH4 sensing valve** opens as soon as pressure is exerted on the suction cup by a **lower** reinforcement called “**trigger plate**”.

The CH4 sensing valve is compatible with stainless steel reinforcement wire or plates (versions D5P and D6P).

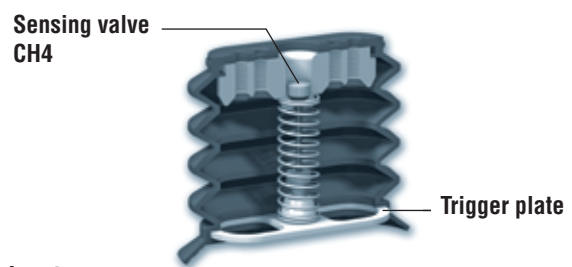

Advantages:

- Valve is adjusted from underneath the suction cup
- Suction cup is evacuated immediately as soon as pressure is applied

Materials:

- Upper insert: POM
- Pin: nylon
- Cone: aluminum
- O-ring: nitrile
- Spring: stainless steel
- Trigger plate: HDPE

Sensing valve with calibrated leakage (CHV_)

COVAL has designed sensing valve solutions with calibrated leakage. Leakage calibration depends on the application and requires an engineering study (available upon request).

3 VSBO, VSBO+

VSBO, VSBO+

40 x 95 mm Bottle Suction Cups with Sensing Valve

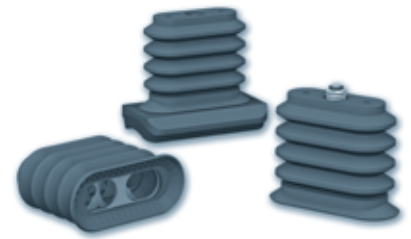

Insert and Reinforcements

Version D5P

- (a) 3 reinforcements: stainless steel wire
- (b) 1 lower reinforcement: polypropylene

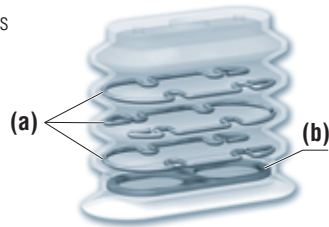

Version D6P

- (a) 3 reinforcements: stainless steel plate
- (b) 1 lower reinforcement: polypropylene

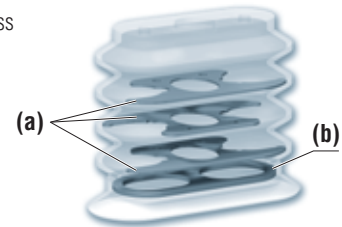

Mounting Hole Distance

VSBO and VSBO+ suction cups offer a choice of two mounting hole distances: 30 or 45 mm.
VSBO+ suction cups include integrated seals for easier mounting.

Available upon request: Vacuum switch connector

The VSBO and VSBO+ suction cups with sensing valve have a $\varnothing 5$ mm connector for a vacuum switch or blow-off valve. This option is only compatible with suction cups with a 45 mm distance between mounting holes.

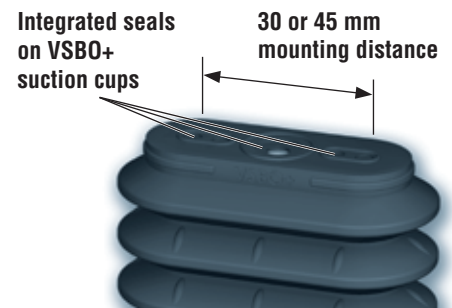

Suction Cup Dimensions

CH2 sensing valve

VSBO
(VSBO4095_D6PCH2_)

VSBO+
(VSBO4095C_D6PCH2_)

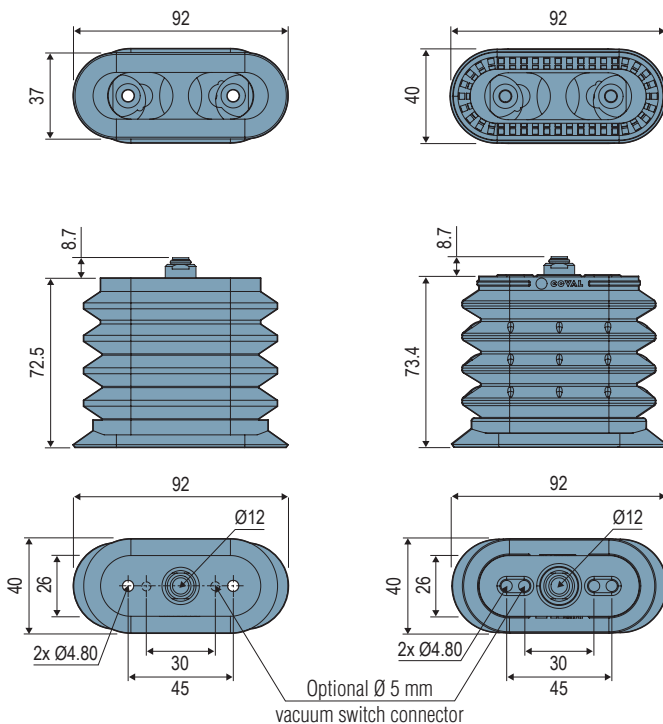

CH4 sensing valve

VSBO
(VSBO4095_D_PCH4_)

VSBO+
(VSBO4095C_D_PCH4_)

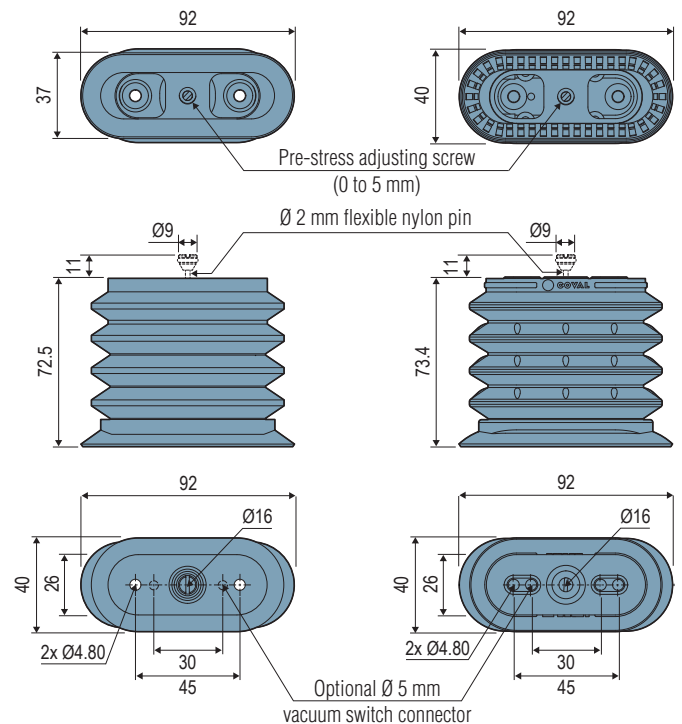

VSBO, VSBO+

40 x 95 mm Bottle Suction Cups with Sensing Valve

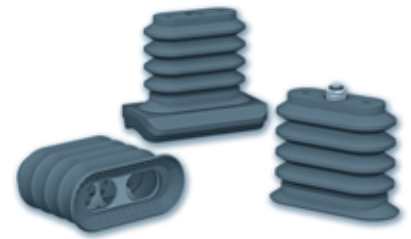

Modular Bottle Suction Cups

VSBO__CH2

VSBO series suction cup VSBO+ series suction cups

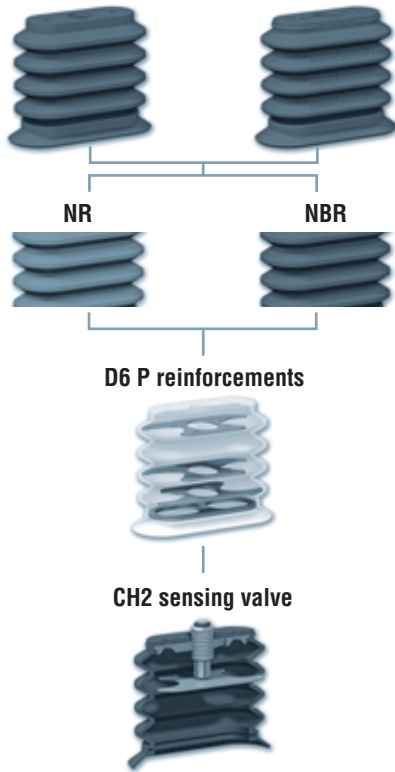

VSBO__CH4

VSBO series suction cup VSBO+ series suction cups

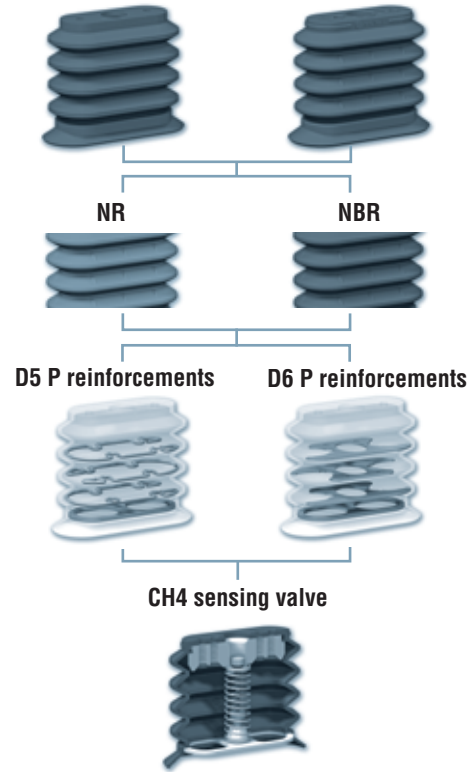

How To Order



VSBO 4095 C NBR D5 CH4 30

TYPE		MATERIAL		REINFORCEMENTS		VALVE TECHNOLOGY		MOUNTING DISTANCE	
Version VSBO	-	Nitrile	NBR	D5P	<ul style="list-style-type: none"> 1 upper insert 3 reinforcements: stainless steel wire 1 lower reinforcement: polypropylene 	CH2	V2 mechanical sensing valve (only with D6P reinforcements)	30	30 mm
Version VSBO+	C	Natural rubber	NR	D6P	<ul style="list-style-type: none"> 1 upper insert 3 reinforcements: stainless steel plates 1 lower reinforcement: polypropylene 	CH4	V4 mechanical sensing valve	45	45 mm

Note: Version CHV_, including valve with calibrated leakage, available upon request.

Note: 40 mm mounting hole distance available upon request

Replacement suction cups without insert or reinforcement



VSBO R 4095 C NBR N16 X 30

TYPE		MATERIAL		Ø OF VACUUM FLOW		MOUNTING DISTANCE	
Version VSBO	-	Nitrile	NBR	N12	12mm Ø of vacuum flow for mounting with mechanical sensing valve V2 (CH2)	30	30 mm
Version VSBO+	C	Natural rubber	NR	N16	16mm Ø of vacuum flow for mounting with mechanical sensing valve V4 (CH4)	45	45 mm

VSBO LM/BM

Bottle Suction Cups with Gripping Interface

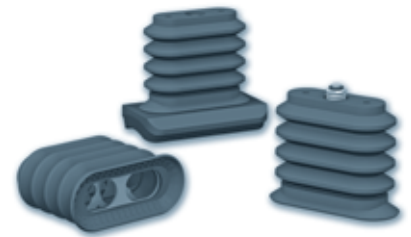

Industry-specific applications



Types of use



To meet the requirements for handling magnum bottles and textured bottles, COVAL has designed a range of 4.5 bellows suction cups, including internal reinforcements and a choice of two gripping interfaces.

- A magnum bottle interface featuring a lip shape and surface suited for the weight and diameter of magnum bottles
- A foam strip interface featuring a support shape and foam strip that compensates for any irregular surfaces on specific types of bottles (e.g. textured or faceted surface, coat of arms, etc.)

To increase the lifting force while maintaining a long travel distance and great flexibility for packing/unpacking applications, VSBO LM/BM suction cups are feature an upper insert, three reinforcements inside the bellows, and a lower reinforcement to fit the desired interface.

The **VSBO LM/BM** series suction cups are designed for handling bottles from the side.

- Version VSBO LM: vertical or horizontal gripping
- Version VSBO BM: horizontal gripping

Materials

Suction cups



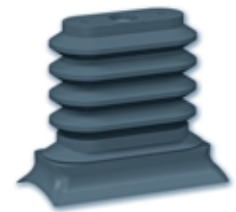
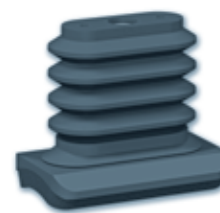

NBR Nitrile

VSBO50105NBR_BM10N



VSBO50105NBR_LMNBR

Suction Cup Characteristics

	 (cm ³)	 (lbf) ⁽¹⁾	 (lbf) ⁽¹⁾	 f ⁽²⁾ (mm)	 (g)
VSBO50105NBR_BM10N	150	35.5	18.6	7 + 34	205
VSBO50105NBR_LMNBR	142.5	55	18.6	2.5 + 34	205

(1) Force measured at 65% on dry and smooth bottles without safety factor.

(2) f = Suction cup deflection.

Bottle Suction Cups with Gripping Interface

For textured bottles

Part no.: **VSBO50105NBR_BM10N**

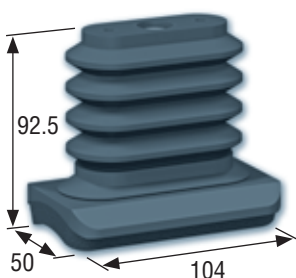

The **VSBO50105_BM10N** suction cup is designed for handling textured bottles. It features a curved gripping interface that fits the shape of the bottle and includes an EPDM foam seal that compensates for any irregular surfaces and guarantees an airtight seal.

For Magnum bottles

Part no.: **VSBO50105NBR_LMNBR**

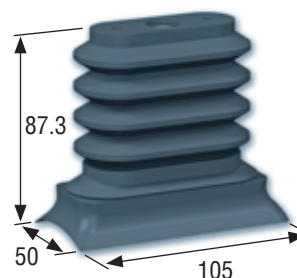

The **VSBO50105_LMNBR** suction cup is designed for handling magnum bottles. It features a lip shape and surface suited for the weight and diameter of magnum bottles.

The suction cup includes the following:

- One stainless steel upper insert
- One nitrile suction cup with 4 bellows, VSBO4095NBR
- Four stainless steel internal reinforcements
- One stainless steel lower reinforcement
- One gripping interface with 10 mm EPDM foam seal

The suction cup includes the following:

- One stainless steel upper insert
- One nitrile suction cup with 4 bellows, VSBO4095NBR
- Four stainless steel internal reinforcements
- One stainless steel lower reinforcement
- One 50 x 105 mm Magnum nitrile lip

VSBO LM/BM

Bottle Suction Cups with Gripping Interface

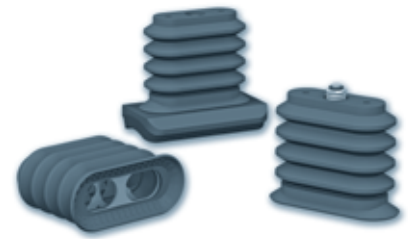

Reinforcements

Version D5

- (a) 1 upper insert: stainless steel
- (b) 4 reinforcements: stainless steel wire
- (c) 1 lower reinforcement: stainless steel

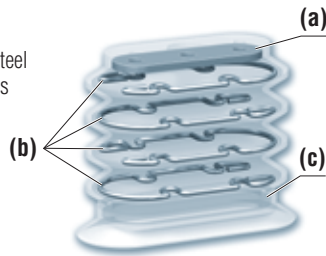

Version D6

- (a) 1 upper insert: stainless steel
- (b) 4 reinforcements: stainless steel plate
- (c) 1 lower reinforcement: stainless steel

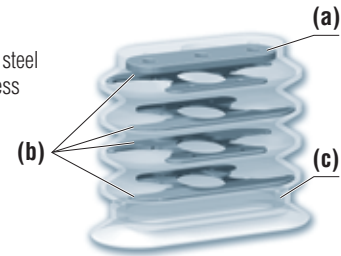

3

VSBO LM/BM

Bottle Suction Cups with Modular Gripping Interfaces

PART NUMBER FOR COMPLETE SUCTION CUPS

including gripping interface with foam seal:

- With stainless steel reinforcement wire (version D5):
Part no.: **VSBO50105NBRD5X45BM10N**
- With stainless steel reinforcement plate (version D6):
Part no.: **VSBO50105NBRD6X45BM10N**

Bottle suction cup
VSBO4095NBR



4 reinforcements:
stainless steel wire
D5

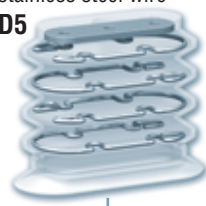

4 reinforcements:
stainless steel plate
D6

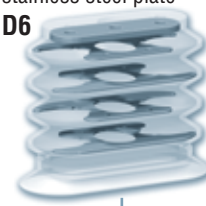

Gripping interface kit with
memory foam seal,
VSBOKIT50105BM10N



Magnum lip kit,
VSBOKIT50105LMNBR

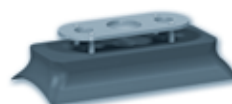

PART NUMBER FOR COMPLETE SUCTION CUPS

including gripping interface with
50 x 105 mm nitrile lip seal:

- With stainless steel reinforcement wire (version D5):
Part no.: **VSBO50105NBRD5X45BM10N**
- With stainless steel reinforcement plate (version D6):
Part no.: **VSBO50105NBRD6X45BM10N**

How To Order

 **VSBO 50105 NBR D5 X 45 BM10N**

REINFORCEMENTS

- 1 upper insert: stainless steel
- 4 reinforcements: stainless steel wire
- 1 lower reinforcement: stainless steel

D5

- 1 upper insert: stainless steel
- 4 reinforcements: stainless steel plates
- 1 lower reinforcement: stainless steel

D6

INTERFACE

BM10N

POM support with 10 mm thick EPDM foam strip

LMNBR

Nitrile Magnum lip 50 x 105 mm

Available upon request: Vacuum switch connector

VSBO LM/BM suction cups feature an optional Ø 5 mm connector for a vacuum switch or blow-off valve.

VSBO LM/BM

Bottle Suction Cups with Gripping Interface

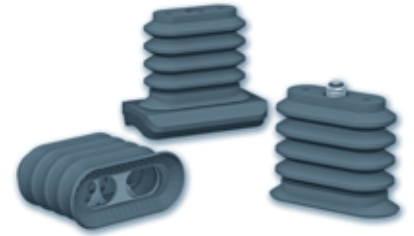

Suction Cup Dimensions

VSBO50105NBR_X45BM10N

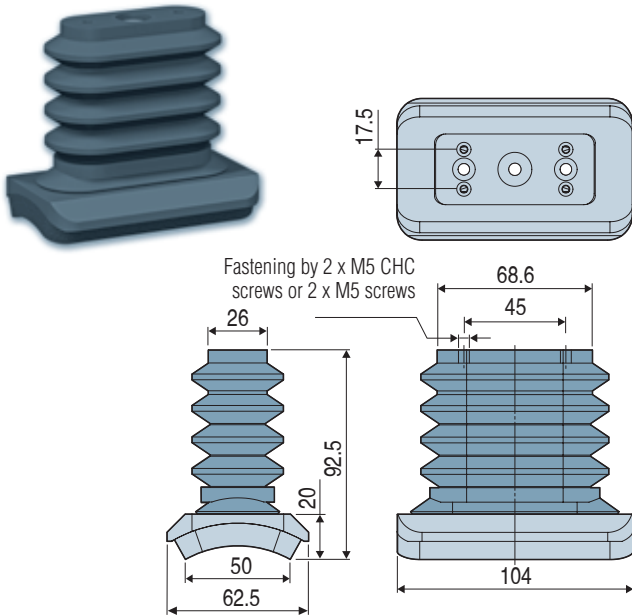

VSBO50105NBR_X45LMNBR

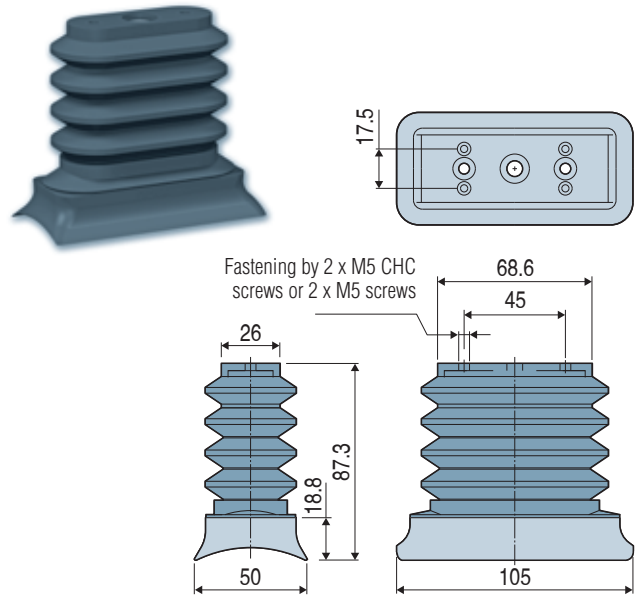

Gripping Interface Kits

Gripping interface kits are used to turn 40 x 95 mm bottle suction cups (part no. VSBO4095NBR) into magnum bottle suction cups or suction cups with a foam gripping interface.

The kits include the reinforcement to fit the interface under the suction cup.

- Gripping interface kit with memory foam seal, 10 mm thick:
Part no.: **VSBOKIT50105BM10N**
- Nitrile Magnum lip kit 50 x 105 mm:
Part no.: **VSBOKIT50105LMNBR**

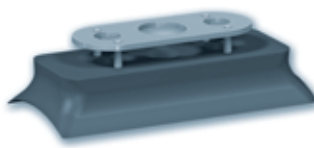
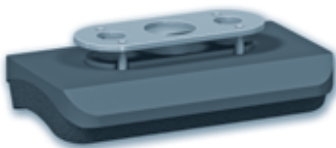

Part Numbers for Spare Parts

- Nitrile suction cup with 4.5 bellows (without insert or reinforcement):
Part no.: **VSBOR4095NBRN6X45**
- POM curved gripping interface with memory foam seal, 10 mm th.
Part no.: **VSBOR50105BM10N**
- 50 x 105 mm nitrile lip:
Part no.: **VSBOR50105LMNBR**

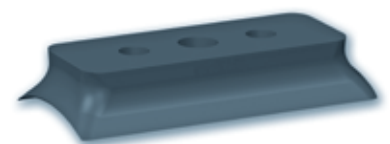
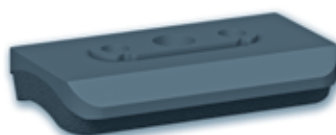

3
VSBO LM/BM